

Tropical Healthy VRF System



TIMS V6

Inverter Multi



CXA/ CXT /MINI VRF

56°C



VRF Development Process

TIMS

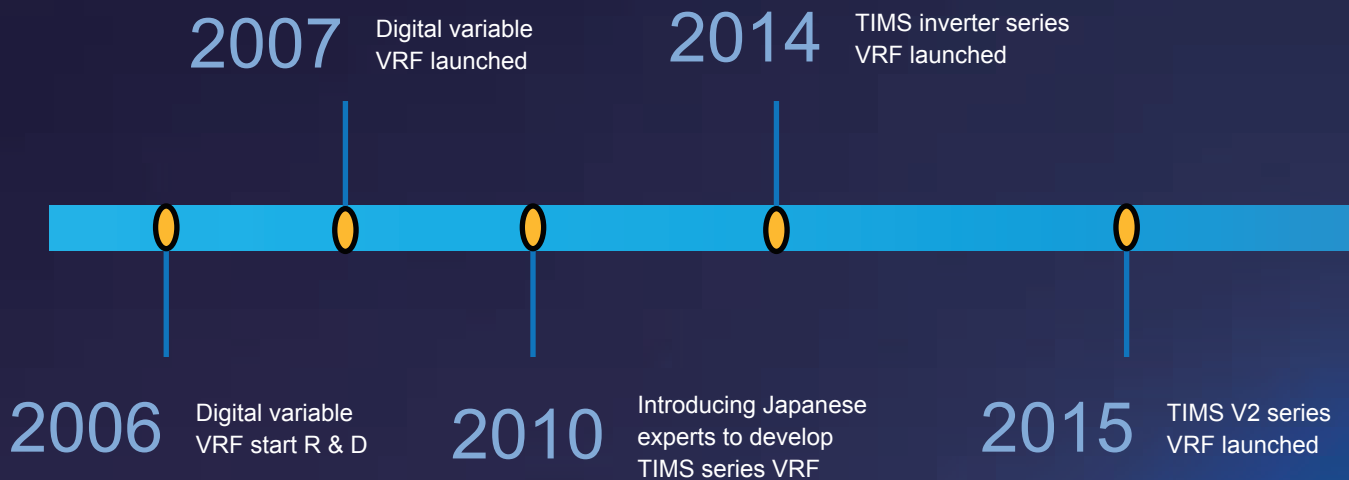

2017 TIMS V4 independent EVI series VRF launched

2019 TIMS V6 independent EVI series VRF launched

2016 TIMS V3 module series VRF launched

2018 TIMS V5 module EVI series VRF launched

2020 The first 22HP single compressor VRF launched in China market



Scientific Research Strength

TICA is the first Chinese central air conditioner brand to establish R&D institute in Japan



Engaged in advanced research on technologies of VRF, heat pump water heater, cryo-refrigeration, heat pump chiller, professional ACU, air purifier, etc.; utilizing talents in Japan to promote the development of Chinese central air-conditioning technology.











Passed T3/T4 Energy Test
SGS - the world's leading testing, inspection and certification company



TICA VRF System successfully passed SGS certified Test, report shows, "the appliance continue to operate satisfactorily for 2 hours non stop without tripping or over heating" and " Total unit energy efficiency ratio (EER) average over 11.03, Power rating (kW/RT) below 1.10"









Product Lineup-Outdoor

HP	8~12	14~18	20~24	26~32	34~64	66~96	
Modular							
	TIMS-CXT	TIMS-CXT	TIMS-CXT/CXA	TIMS-CXA	TIMS-CXT/CXA	TIMS-CXA	
kW	10~18	18					
Mini VRF High efficiency series							
	TIMS-AHT (220V)	TIMS-AHT/AHTA (380V)					
kW	8~18	20~22.4					
Mini VRF Classic series							
	TIMS-CHR (220V)	TIMS-CHRA (380V)					

AHU KIT

Model	Cooling capacity (HP)	Indoor unit capacity (kW)	Reference air volume (m ³ /h)	Picture
TMDK280	8	20~25	3000	
	10	25~30	3700	
TMDK450	12	30~36	4500	
	14	36~40	5400	
	16	40~45	6000	
TMDK900	18	45~61	9000	
	26	61~73	10000	
	32	73~90	13000	

Product Lineup-Indoor

Capacity (kW)	Picture	2.2	2.5	2.8	3.2	3.6	4.0	4.5	5.0	5.6	6.3	7.1	8.0	9.0	10.0	11.2	12.5	14.0	16.0	
Round flow cassette				•		•		•	•	•	•	•	•	•	•	•	•	•	•	•
One-way cassette				•		•		•		•		•								
Two-way cassette				•		•		•		•		•	•							
Slim duct (purification type)		•	•	•	•	•	•	•	•	•	•	•								
Medium static pressure duct														•	•	•	•	•	•	•
Ceiling & Floor				•		•				•		•		•		•	•	•		
Wall-mounted				•		•	•			•										
High static pressure duct																•	•	•	•	
High static pressure duct				20kW / 25kW / 33.5kW / 40kW / 45kW / 50kW / 56kW / 61.5kW																
All fresh air duct				120A-020 / 175A-022 / 210A-020 / 250A-015 / 250A-020 / 250A-030 / 300A-020 / 400A-020 / 400A-020 / 400A-030 / 500A-030 / 600A-020 / 600A-030																

INDEX

Outdoor Unit P6

TIMS V6 Series	P6
TIMS Mini VRF	P43

Indoor unit P50

Round Flow Cassette	P52
Two-way Cassette	P55
One-way Cassette	P57
Medium Static Pressure Duct	P59
Slim Duct	P61
High Static Pressure Duct	P64
Full-fresh Air Handling Unit	P66
Wall-mounted	P68
Ceiling & Floor	P70

Fresh Air Solutions P72

Indoor Air Purification Unit	P73
HRV	P74
Standard Series Fresh Air Ventilators	P75
High-end Series Fresh Air Ventilators	P75
Electronic Fresh Air Smog Removal Sterilizer	P76
Electronic Return Air Purifier	P76

Intelligent Control P77

Remote Controller And Wired Controller	P78
Centralized Controller	P79
Building Management System (BMS)	P80
Remote Control System	P81
Intelligent Software	P82

Branch Pipe P84

TIMS Healthy VRF

Dedicate Design, Premium Quality



Filtration



Energy-saving



Comfort



Reliability



Convenient Application



Outdoor Unit

Four stage filtration

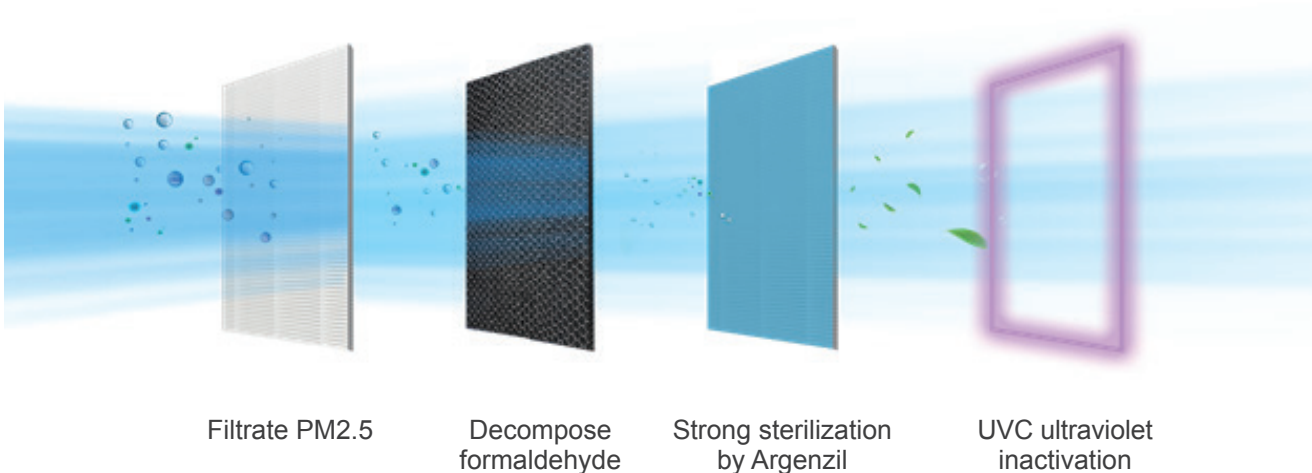

► Enjoy the freedom of breathing

Use patented electrostatic friction filter to remove PM2.5/PM0.3 .

The primary purification efficiency of PM2.5 is up to 95% ,and the CADR is over 400 m³/h in a 30m³ lab module.

► Protect healthy life

Use chemical formaldehyde removal filters to decompose formaldehyde.

High selectivity and no secondary release.

The efficiency is up to 95% in a 30m³ lab module.

► Return to safe environment

Use Argenzil and UVC to sterilize and inactivate.

The sterilization efficiency of Ag⁺ is 60000 times that of alcohol.

UVC light can denature and dissociate protein.

The primary purification efficiency of microbe is up to 90%.





Energy Saving

Creating more value for you

9.6

IPLV(C)
up to 9.6

20%

Performance improved
by up to 20%*¹



EVI compressor



Secondary sub-cooling



DC fan motor



Heat exchanger design



Multiple operating modes

Outstanding energy-saving efficiency

► Industry-leading IPLV(C)

Owing to the solid R&D capacity and excellent system design, TICA is able to create products with higher energy efficiency and the IPLV(C) can be up to 9.6, far exceeding national EEI level 1.

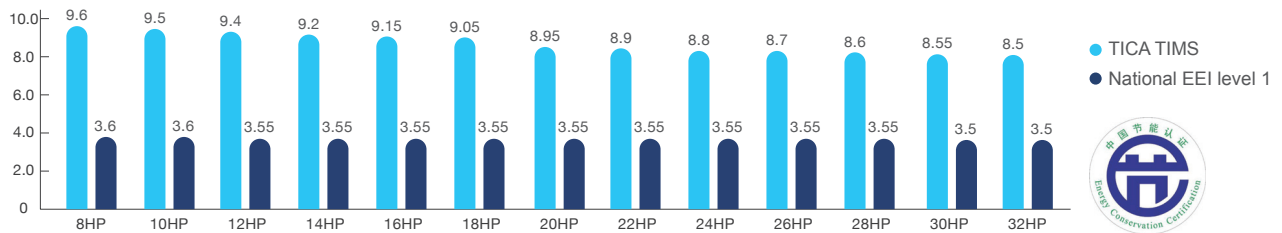
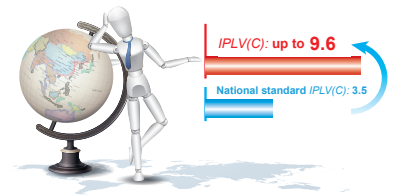

Importance of IPLV(C): providing more accurate evaluation on the energy saving performance of air conditioners in a scientific way.

► Excellent EER

The advantageous system design achieves high EER for the TIMS low temperature and strong heat unit in low temperature conditions. When the outdoor temperature is -15°C, the unit features higher energy efficiency in heating mode.

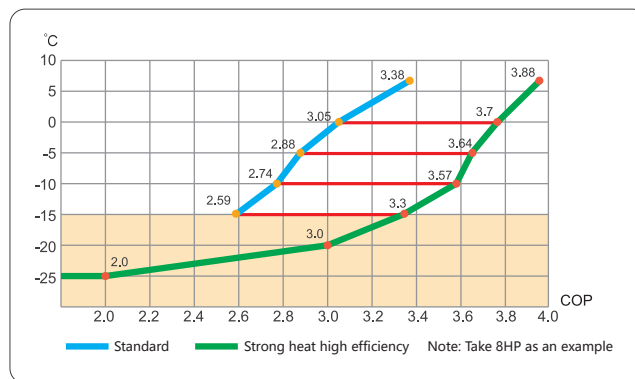

New EVI scroll compressor

1 Pressure relief valve

It reduces over-compression loss and increases compressor efficiency, especially at medium and low pressure.

2 New compact scroll coil

Compact scroll coil can substantially increase compressor displacement.

3 Air jetting port

EVI technology and dual-air injection design further improve the cooling and heating capacities of the unit.

4 New bearing material

New compressor bearings are adopted to make the compressor more reliable.

5 More reliable differential-pressure oil supply system

The differential pressure oil supply ensures the reliability of the compressor operating at a low speed.

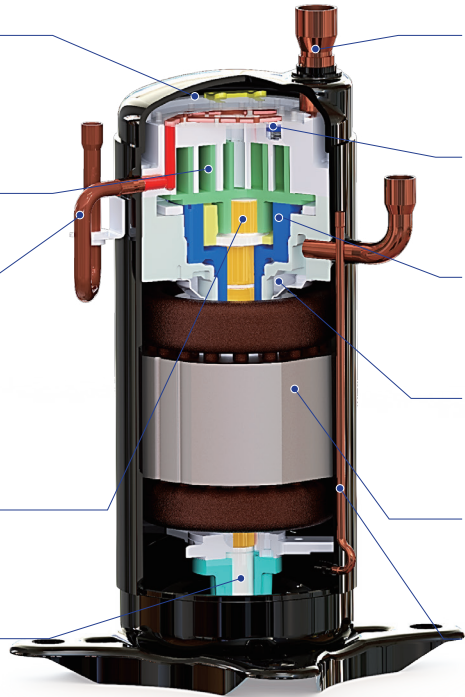

6 Air return port

Copper plated steel tube makes the material stronger and more reliable, thus enhancing the performance of large-capacity units under high-speed running.

7 Vapor injection pipe valve

This design can prevent air leakage from the vapor injection pipe in non-injection conditions, so as to improve system performance and stability.

8 Compliant scroll technology

Mitsubishi patent compliant scroll technology is adopted to effectively reduce compressor air leakage and energy loss due to frictions, thus improving compressor performance.

9 Unique air discharge system

The air discharge pipe is directly connected to the internal frame of the compressor, which could result in the decrease of compressor oil discharge.

10 Permanent-magnet motor

More advanced permanent-magnet material and new and special design achieve higher efficiency with less running current.

11 More stable oil balance mechanism

The reliable oil balance mechanism contributes to more stable operations of multiple compressors connecting in parallel.

► EVI technology

When the ambient temperature reaches the limit condition, the heat exchange capacity of the outdoor unit declines, and the air return volume of the compressor is reduced, accompanied by problems in compressor suction and discharge protection. The TICA TIMS VRF unit adopts the high efficiency EVI system and cooperates with TICA's new inverter control and refrigerant system. In the unit, refrigerant is added through the air jetting port to increase the displacement, so as to broaden the cooling and heating ranges of the unit, enhance the overall capacity by 20%. In addition, the added refrigerant is injected into the pressure chamber of compressor to reduce the compression ratio and power consumption of the compressor, and improve the COP value by 10%. The low-temperature gaseous refrigerant inhaled by the air jetting port effectively reduces the temperature for the compressor and ensures high efficiency as well as more stable and reliable operation of the compressor.

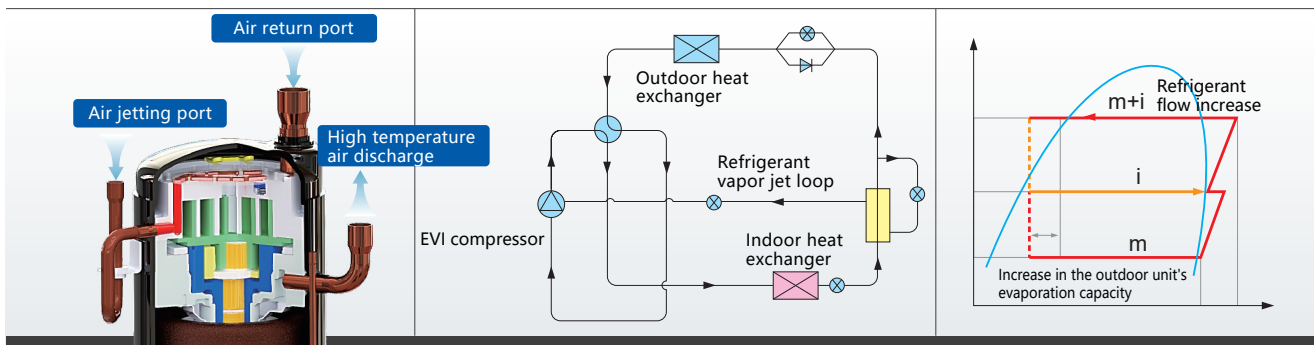

► Stepless capacity regulation

Based on the full DC inverter technology, the combination of high-strength shaft and top-edging oil control technique allows for outstanding fast and efficient running of the compressor with an ultra-wide speed range of 0~480Hz, with an accuracy as great as 0.01Hz. Also, continuous and precise control of the compressor speed and system output is also supported through intelligent adjustment based on actual demand, so as to guarantee linear output from low speed to high speed and achieve stepless capacity regulation of the compressor.

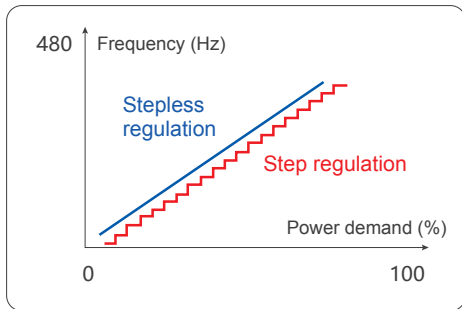

► Compliant scroll technology

The compliant scroll compressor technology features high volumetric efficiency, low attenuation at low temperature and flexible floating sealing, which substantially increase the liquid hammer resistance. Compared with rotor compressors, compliant scroll compressors are more efficient and have a longer service life.

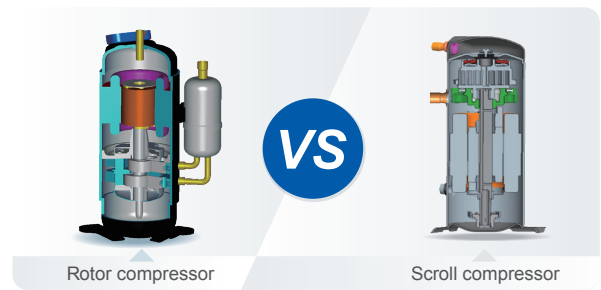

► 180° sine DC inverter control

The cutting-edge permanent-magnet sensorless synchronous motor technology ensures smooth sine curves of current output from the DC inverter, thus guaranteeing stable operation of the motor with less vibration, facilitating motor turning, and substantially increasing the efficiency with effective EMI prevention.

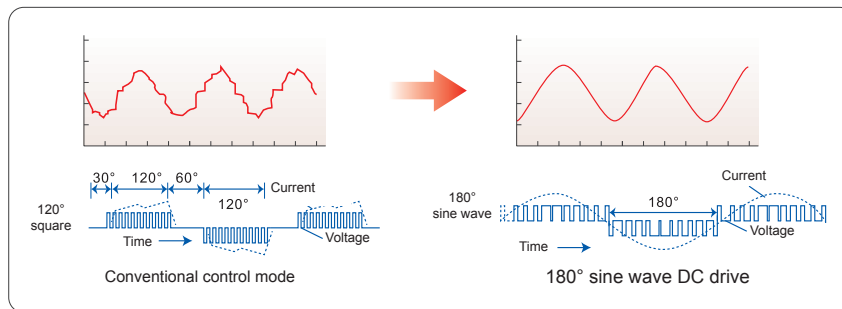

In cold regions where the outdoor temperature in winter is low, VRFs with conventional heat pump circulating fail to generate sufficient heat and present a low energy efficiency. Therefore, air source heat pump products, including VRFs, are not widely used in northern regions. Main methods to resolve the problem of heating capacity attenuation of air source heat pumps under low temperature include auxiliary electric heater, two-stage compression refrigeration cycle, cascade refrigeration cycle, and EVI technology. Among them, auxiliary electric heater delivers a low level of comfort, has a low heating efficiency, and is not safe enough during use; cascade refrigeration system is too complex and will increase the manufacturing, operation and maintenance costs. Generally, EVI technology is the best option.

—Bluebook

DC inverter fan motor



The ODU fan motor adopts the DC inverter motor that features an 45% increase in efficiency and substantial decrease in power consumption. Stepless speed control of the fan based on environmental conditions and air conditioner load, together with the stepless inverter technology of compressor, can achieve highly precise control for more stable and reliable operation.

► Stepless speed control by frequency variation

Stable discharge/suction pressure of compressor, enhanced system reliability.

Stable and dynamic allocation of refrigerant flow (unit capacity), guaranteed IDU capacity.

Fast control of system speed, better response to rapid change in air conditioning load.

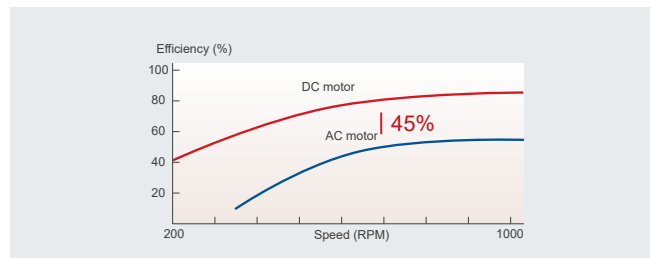
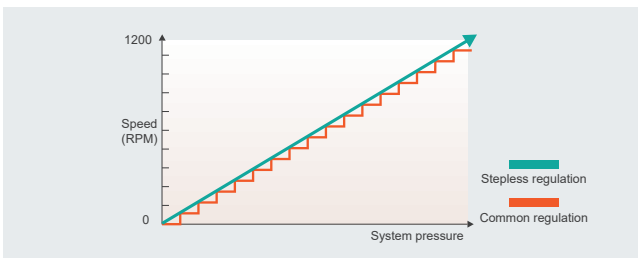

Secondary sub-cooling

TICA inverter VRF ODU adopts the efficient heat exchanger to achieve 12°C stage-1 super-cooling, and 20°C stage-2 super-cooling with the quality plate heat exchanger. The total super-cooling degree reaches 32°C, thus guaranteeing high efficiency and stability of the system, and substantially improving the performance of long piping.

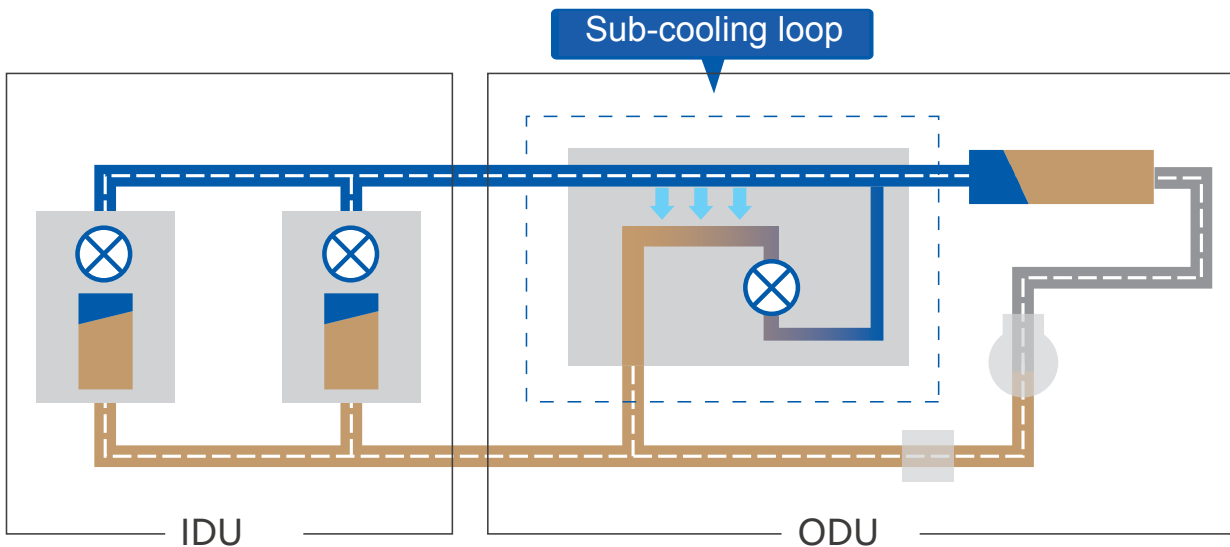

New outdoor heat exchanger

The ODU heat exchanger adopts the ϕ 7.0 internal thread efficient heat-conducting copper tube and new aluminum fin, as well as the one-off processing technology, to provide larger heat exchanging area. It also features more rational fan speed distribution, reduced air flow resistance, and more sufficient heat exchange. System heating performance is less likely to be affected by frosting.

► High-efficiency inner-threaded copper tubes

The quality and efficient copper tube with internal thread design provides larger contact area with refrigerant, and thus substantially increasing the heat transfer efficiency.

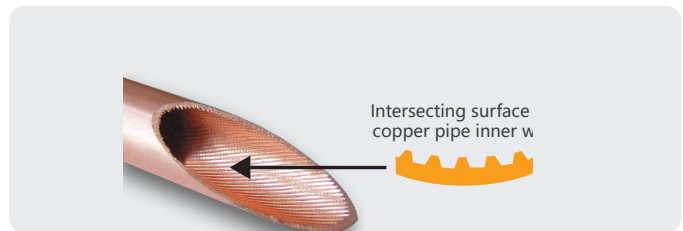

► TTO design

The specially designed TWO-TO-ONE refrigerant loop can effectively increase the amount of liquid refrigerant. As a result, less resistance to refrigerant flow can increase the comprehensive coefficient of heat transfer and further optimize the system.

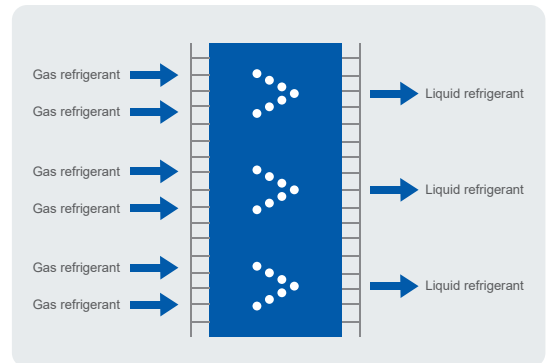

Multiple operating modes

24x7 energy saving



The 24x7 smart energy-saving mode of TICA VRF supports automatic analysis and mode change. Users can experience the energy-saving operation in a more convenient and intuitive manner.

Seasonal energy saving



By monitoring the temperature, the unit can automatically select a proper running mode depends on the season to minimize power consumption in spring and autumn.

Peak-valley energy saving



Based on the peak and valley demand periods in different places in the country, as well as the unit running status and usage, the unit can automatically adjust the running mode to suit demands in various periods with the minimum operating costs.

Comfort

Bringing you enhanced comfort

16

All-dimensional
silent technologies

23dB(A)

IDU noise as low
as 23dB(A)*2



Ultra-silence



Fast cooling/heating



Precise temperature control



Smart defrosting



16 professional noise reduction technologies

- | | |
|--|---|
| 1 High-efficiency low-noise DC inverter compressor | 9 Low noise priority mode |
| 2 Stepless brushless DC motor | 10 Three silent modes: Smart/Night/Forced Silent |
| 3 Motor bracket with off-resonance framer | 11 Compressor jet loop noise reduction |
| 4 Unique air injection noise reduction | 12 180° sine wave control for quiet operation of compressor |
| 5 Omni-directional acoustical enclosure | 13 3D simulation pipe vibration reduction |
| 6 New guide ring | 14 Streamlined air outlet grille |
| 7 750mm large fan | 15 ODU casing anti-vibration design |
| 8 Refrigerant flow noise reduction | 16 Fan anti-vibration with CFD |



► Omni-directional sound insulation

The four-layer sound insulation of "PET mat + PVC rubber + NT pad + PVC rubber" achieves better noise reduction. All the sound insulation materials are of textile level, and with flame retardant agent added to meet more strict requirements for environmental protection and safety.



► Unique air injection noise reduction

EVI pipeline is equipped with the special steel muffler that features high strength and rigidity, to effectively offset the high vibration and destructiveness of EVI pipeline. In addition, the professional T-shaped silencing technology can effectively reduce noise and pipeline vibration, and further prevent the liquid refrigerant from entering the compressor and causing liquid hammer.



► New air guide shield

The guide ring features excellent weatherability and will not turn yellow or crisp even after being used for a long time under severe conditions. The air duct inlet adopts the curved surface design to avoid generation of vortexes and reduce the vibration of air duct due to air impact. Compared with conventional designs, the air flow is increased by 1300m³/h and the noise is reduced by 1.5dB.

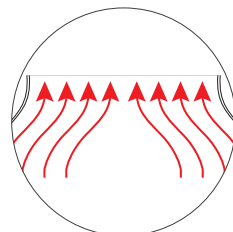

► 750mm large fan

The four-blade 750mm large axial flow fan supports large air flow at low speed. This can substantially reduce the power consumption of the motor. Based on the CFD technology and aerodynamic simulation technology, the optimal blade shape and twist angle can minimize the vibration generated by the fan during its high-speed running and thus avoid resonance vibration with the unit. Besides, special insulating composite materials are adopted to effectively reduce the fan operating noise.



► Three silent modes

Night silent mode

The system adopts the delay judgment mode based on the outdoor ambient temperature peak. Meanwhile, it will automatically determine whether to enter the night silent mode according to the current ambient temperature and load size.

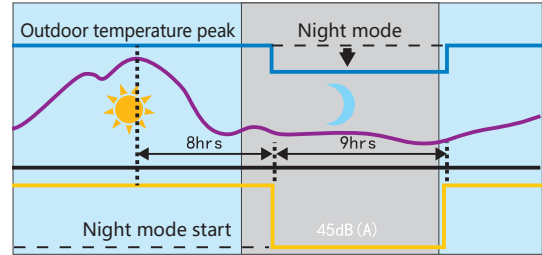

Forced silent mode

In scenarios with a stricter silent requirement, users can select the forced silent operation mode as required to reduce the operation noise of the unit and create a quieter and more comfortable environment.

Smart silent mode

After smart silent mode is selected, the unit may Test duty ratio real time and system running state, and automatically enter silent mode to minimize unit running noise, ensuring passenger comfort.

Fast cooling / heating

The large-capacity inverter compressor and fast soft-start can achieve an ultra-strong instantaneous output, and reach 100% system capacity in 80 seconds, to meet the load requirements for indoor air conditioning.

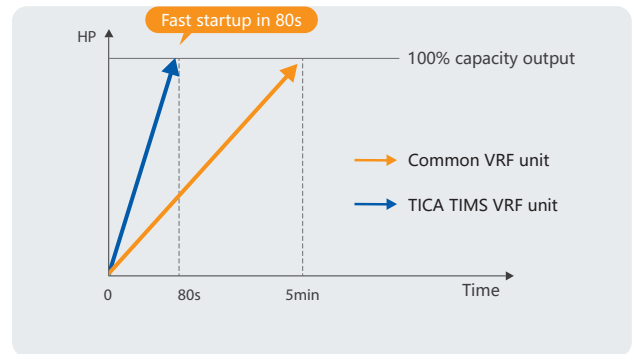

Pricise temperature control

The various sensor detection systems (including the compressor outlet pressure and temperature sensor, outdoor temperature sensor, air outlet temperature sensor, evaporator temperature sensor, etc.) detect the ambient temperature, actual room temperature and refrigerant evaporation temperature in a timely manner, to ensure the optimum performance of the system. The indoor temperature is kept within an accuracy range of $\pm 0.3^{\circ}\text{C}$, ensuring a more comfort indoor environment.

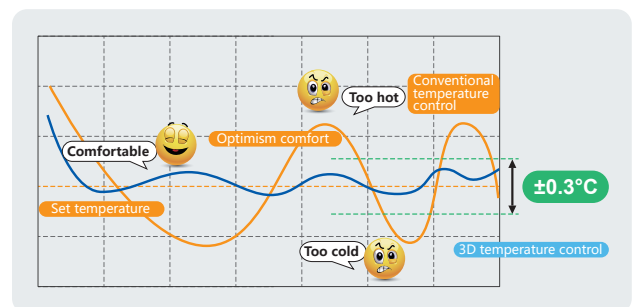

Intelligent defrosting technology

► TCC defrosting

The innovative TCC defrosting technology of TICA adopts the non-stop method for defrosting. Modular units do not need to switch to the cooling mode for defrosting in winter. In this way, the IDU air supply temperature is more stable and the system noise is lower (patent No.: ZL 2013 2 0344961.5).

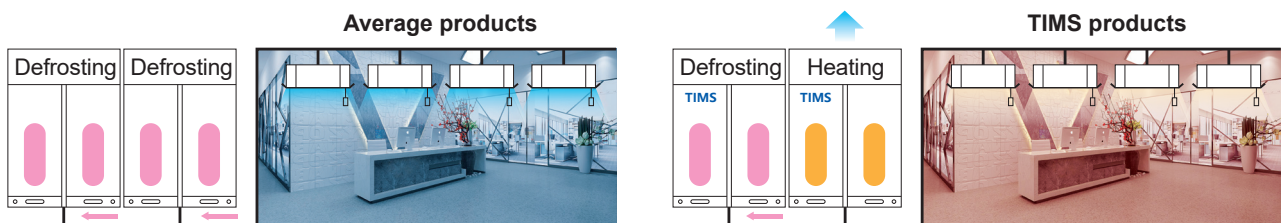

► Smart defrosting/defrosting self-adapting

Smart control can effectively reduce the times of defrosting, prolong the heating period, and improve the heating efficiency. Temperature sensors and pressure sensors in the system can precisely determine when to start defrosting based on the analysis on the temperature, pressure, current and other major parameters during heating operation. When there is a need for defrosting, the defrosting operation will be started. When there is not such a need, the system will keep the heating operation. In this way, the defrosting duration can be shortened to 3 to 5 minutes.

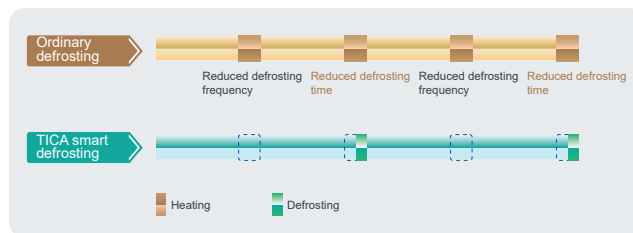

► Anti-frosting at the bottom

The patented anti-frosting design at the bottom can ensure that the ice water mixture at the bottom of unit can be completely removed during defrosting in heating mode in winter, so as to avoid impact on the heating capacity, improve the unit stability, and shorten the defrosting duration by 30%, providing better heating experience for users.

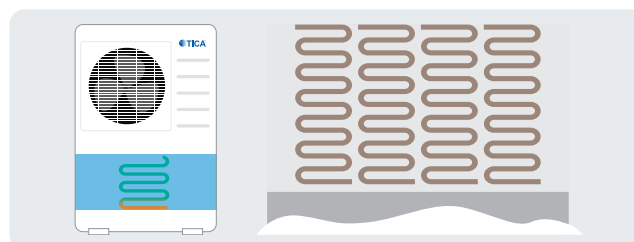

► Optimized defrosting control with fan current adaptive technology

The innovative fan current adaptive technology can optimize the defrosting control. Through adaptive learning, the system can establish functional relations between the fan speed and fan current and the degree of frost when the system high/low pressure and temperature parameters are different, and based on which, to determine the degree of frost by the fan current.



► Drying after defrosting

After defrosting, small amount of water may exist on the surface of heat exchanger. If the system starts heating right away, the residual water may lead to rapid frosting. To avoid this problem, TICA products have a drying procedure after defrosting by optimizing the control sequence of the compressor, 4-way valve, and fan, to dry and blow away the water on the surface of heat exchanger and make the defrosting process more effective.

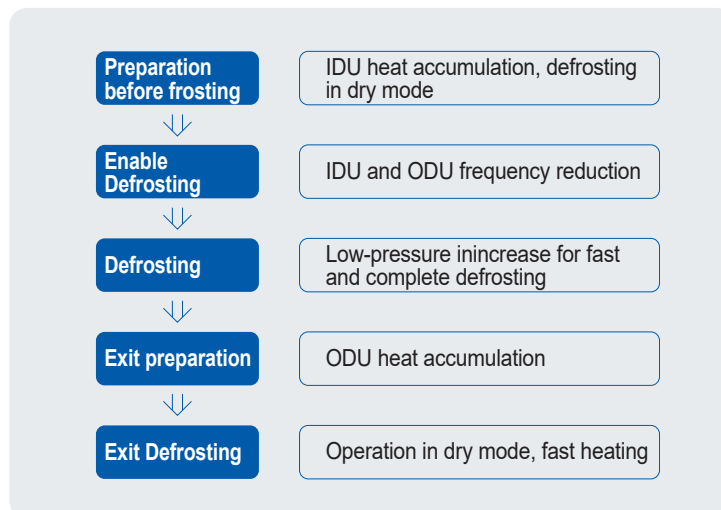



Reliability

Provide you with healthy air

8

Oil return technologies

Multiple

EXVs



8-stage oil return



Micro-HEX technology



Multiple protections



Duty cycling



Backup operation



Auto snow-blowing



Dust-clean

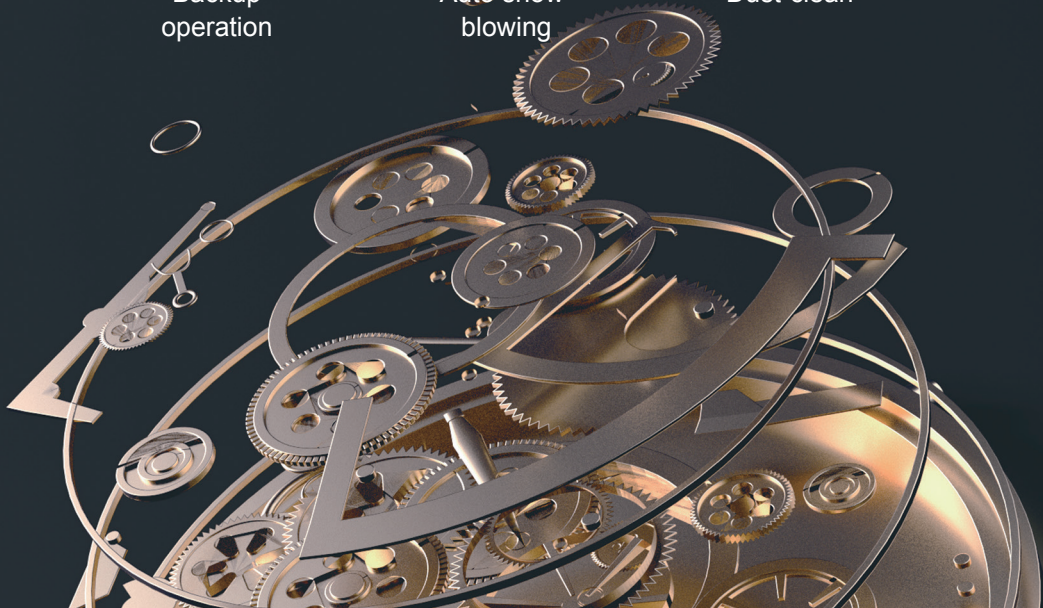

Importance of oil return

In a VRF system, lubricating oil is required to keep the high speed running of compressor. However, when the system is running, the lubricating oil will be removed together with the refrigerant from the compressor and enter into the system. Too much lubricating oil can block the system and reduce the heat exchange efficiency. If oil return is not carried out, there will be insufficient lubricating oil in the compressor.

► 8-stage oil return technologies

Through the oil separation technology, oil distribution technology, oil balance technology, oil storage technology and oil return control technology, the system achieves oil balance between compressors and between ODUs, so as to guarantee the safe and reliable running of the system and achieve 99.99% oil return.

1. Efficient oil separation and return technology of compressor

The highly efficient high-pressure-cavity compressor is equipped with multiple oil separation technologies through blockage, centrifugal and gravity methods, as well as the compressor pressure difference oil supply and smart oil level control technologies, and high oil tank structure at the bottom to keep the oil level stable, prevent too much lubricating oil from entering the refrigeration pipeline, and maintain sufficient oil for normal operation of the compressor.

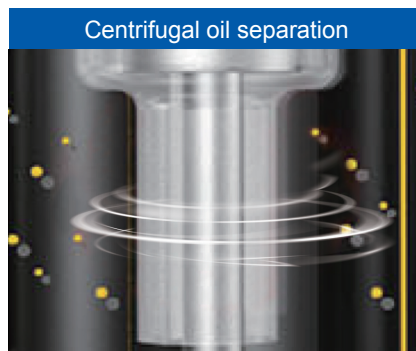

2. Staged oil storage

After the lubricating oil is separated from the refrigerant by the oil separator, a small amount of lubricating oil is stored in the oil separator, and most lubricating oil will return to the compressor. After entering into the compressor, part lubricating oil is used for the normal operation of the compressor, and the rest will enter into the gas-liquid separator through the compressor's oil balance pipe. With the efficient filter, the oil return performance is guaranteed, and most lubricating is stored in the gas-liquid separator to achieve staged oil storage.

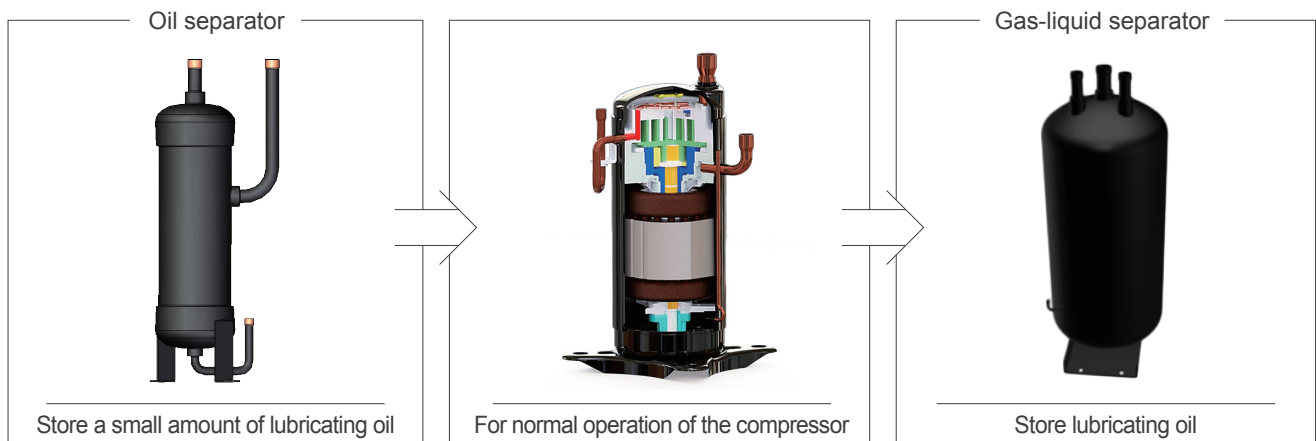

3. Speed-difference cyclone-type centrifugal oil separation

The large-capacity high-efficiency oil separator is adopted. The specially designed diameter of inlet and outlet pipes and cyclone-type oil separation track can increase the centrifugal force and provide high speed oil taking at the inlet. The large-capacity and high barrel guarantees effective separation of lubricating oil, with an oil separation efficiency of 99.99%. The oil can be sent to different compressors in a timely manner to make sure that all compressors are supplied with sufficient oil for normal operation.

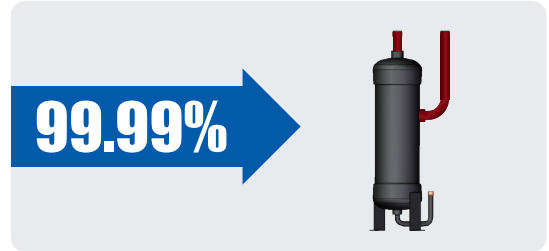

4. Equal-resistance gas-liquid separator

Equal-resistance gas-liquid separator is adopted to precisely control the refrigerant amount and reduce the container volume. The equal-resistance design can ensure equal distribution of refrigerant and lubricating oil for compressors. In this way, the system running is more stable and the compressor service life is longer.

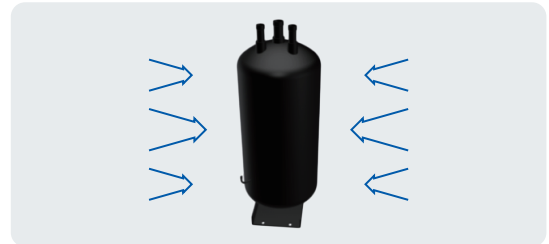

5. No oil balance pipe

There is no oil balance pipe between ODU's. The installation is simple and efficient. By collecting data about capacity output of different modules, the system can automatically control the lubricating oil distribution of modules, decide the running duration of modules, and guarantee stable system operation.



6. Smart oil balance design

The special oil return system pipeline (patent No.: CN203385240U) allows transfer of excessive lubricating oil from the compressor for reallocation, and achieve oil balance among compressors in the same system.



7. Precise oil return control

Based on the quantity of running compressors, compressor running frequency, compressor running duration, compressor start/stop times, and high pressure and low pressure, the system can precisely determine the status of lubricating oil in the heat exchanger and pipeline, and implement precise control to achieve efficient oil return when the system is running with low load and starts/stops frequently, and avoid unnecessary oil return when the system is running with high load.



8. Dual-mode intelligent oil return control

In heating mode, the system adopts dual-mode oil return to intelligently select reverse oil return and non-reverse oil return. In this way, the oil return operation is efficient and the indoor temperature fluctuation is maintained to the minimum.

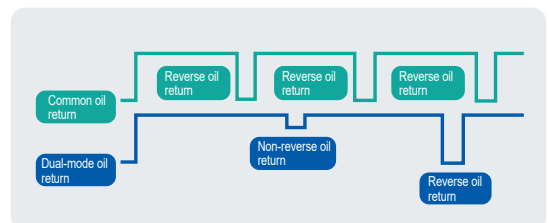

Micro-HEX technology

With the innovative Micro-HEX refrigerant-cooling scheme and the unique aluminum board heat dissipation technology, the cooling performance of TIMS VRFs is substantially enhanced. The temperature difference between the IPM module and the refrigerant (usually 30~55°C) can be reduced to less than 5°C. Stable output can be guaranteed even under harsh operating conditions.

1. With the innovative micro-ripple and special section structure, the heat exchanging area is twice that of ordinary refrigerant-cooling schemes (ϕ 12.88mm circular pipe). Liquid-side heat exchange coefficient up to 300W/m²·K. The IPM module surface temperature can be controlled under 60°C to minimize the system pressure loss with efficient heat exchange guaranteed, allowing reliable performance of the unit even at high load.

2. TICA refrigerant-cooling scheme adopts only the two-layer thermal resistance of radiator panel and thermal conductive silicone. In contrast, conventional refrigerant-cooling scheme adopts at least four layers of thermal resistance of copper pipe, gap, thermal conductive silicone and radiator, and the heat dissipating capability is low.

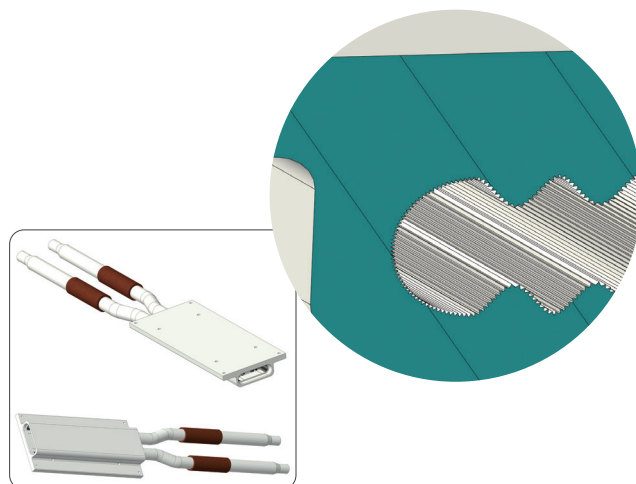

System capacity distribution

Studies have shown that, when a VRF unit operates with a 40%~75% load, the unit power consumption is the lowest and the EER is the highest. Through adjustment in both the time and load perspectives, TICA TIMS VRFs can make the two compressors of a modular unit or the same module operate with a 40%~75% load to ensure the optimum energy efficiency.

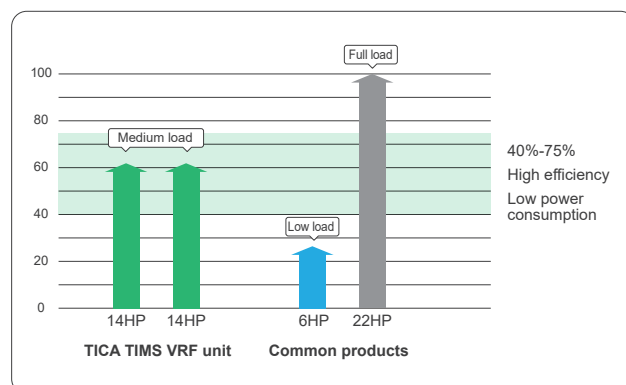

Multiple protection functions

► Compressor protection

New inverter compressor with high pressure cavity and four protection functions for more efficient and reliable operation.

1 High temperature protection

The external new thermistor temperature sensor can send temperature signals faster and more accurate to make the protection more efficient.

3 Freezing protection

In case of startup under low temperature, the equipped oil heater can automatically preheat the refrigerant oil.

2 Demagnetization protection

The compact reluctance-type DC motor has low noise and comes with the unique demagnetization protection design.

4 Overcurrent protection

The built-in overcurrent protector can guarantee normal operation of the motor.



► Multiple protection



Emergency stop

In emergencies, the unit can be stopped forcibly to avoid major risks and damages.



Compressor and motor overheat protection

Multiple temperature sensors are installed to effectively prevent scroll coil wearing, oil carbonation and deterioration, and motor damage due to overheating compressor or motor.



Power phase sequence protection and grounding

The unit is equipped with a surge protection. In case of exceptions such as phase sequence error and phase loss, the controller will record the power supply failure, generate an alarm, and stop the unit.



Compressor exception protection

Suction and discharge temperature protection, high/low pressure protection, oil return protection, compression ratio protection, overload/overcurrent protection, and anti-liquid hammer protection of compressor.



Power high/low voltage and current protection

The ODU can directly identify the power supply signal. When the power supply is insufficient or excessive, the ODU can send directions to the IDU and prevent IDU startup, so as to effectively protect the system.



Inverter EMI protection and temperature protection

The system adopts the high-precision inverter to suppress harmonic currents and presents strong electromagnetic immunity. When the system detects an overheating inverter, it will automatically start the inverter temperature protection function to prevent the inverter from being damaged.

► IDU anti-freezing protection

By checking the heat exchanger surface temperature of IDU, the unit can close the IDU EXV and stop the IDU when frosting or freezing may occur.

► Anti-reverse rotation protection

When an external force is exerted to reversely rotate the ODU fan, the air conditioner starts to stop the reverse rotation of the fan, and then make the fan rotate normally.

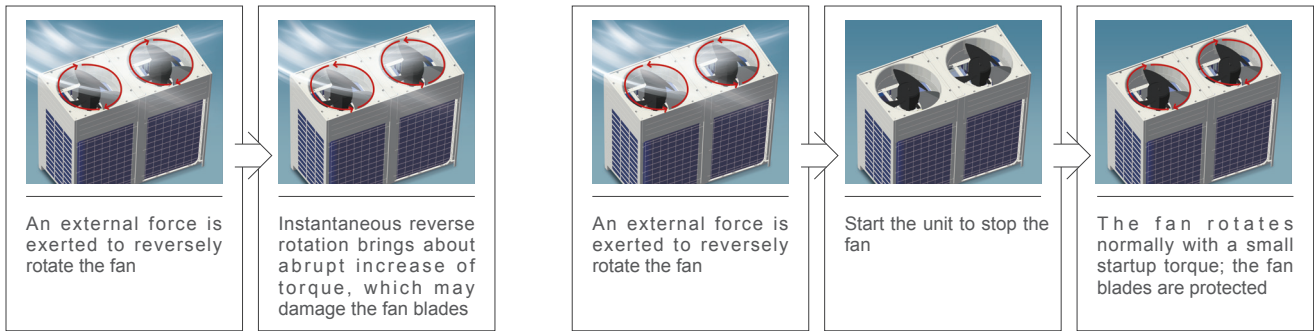

Conventional

Anti-reverse rotation protection

► Lightning protection

The ODU can be equipped with a lightning protection module to prevent interference and protect the unit against lightning surge. In this way, the system operation is more reliable and stable.



► Control board SMT surface mount

All control boards adopt the SMT surface mount technology to effectively enhance the anti-noise jamming performance and protect them against sand blown by wind and humidity, so as to prolong their service life.

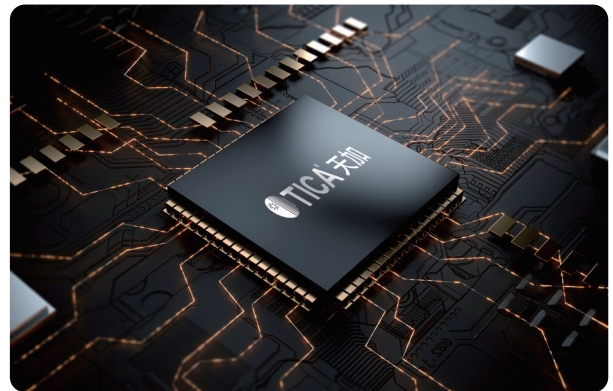

► Anti-corrosion

To meet the requirements in severe conditions with high humidity and high level of salt fog in places near seas and rivers, TICA ODU casing adopts thickened sheet metal and multiple advanced spraying techniques to effectively improve the corrosion resistance performance and extend the service life of the air conditioning unit.



Corrugated fins with openings are adopted. The heat exchanging area is 15% larger than flat sheets, and the heat exchanging performance is higher.

The corrosion-resistant layer can effectively slow down the corrosion of heat exchanger by corrosive gases. Thanks to the hydrophilic layer, frosting is less likely to happen during heating operation of the air conditioner, and the drainage during defrosting is more convenient.

The lubricating layer can break the surface tension of water, speed up the dropping of condensing water or frost-turned water.

The IDU panel passed the anti-aging test. This ensures that, in everyday use, the panel does not age under strong UV, high temperature, or high humidity conditions.

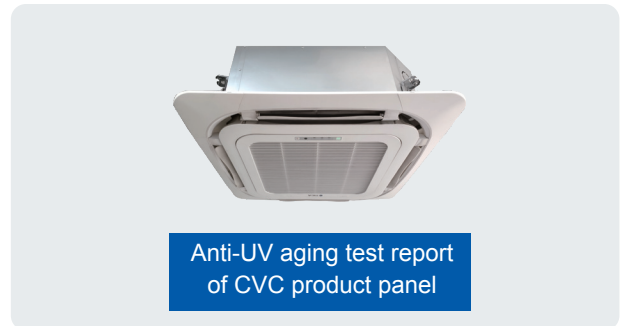
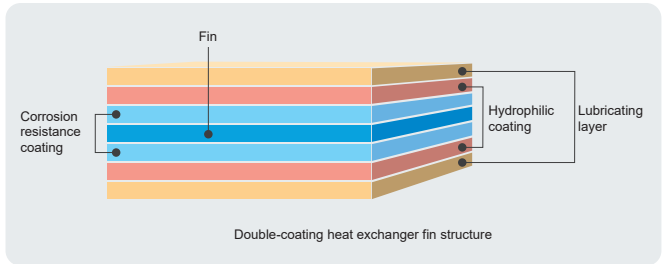

► Multi-EXV control

A single ODU module is equipped with multiple EXVs, and each EXV supports 480-stage refrigerant flow adjustment for precise control of refrigerant circulation, so as to create a more comfortable indoor environment based on the actual requirements of IDU. (3000-stage refrigerant flow adjustment is customizable)

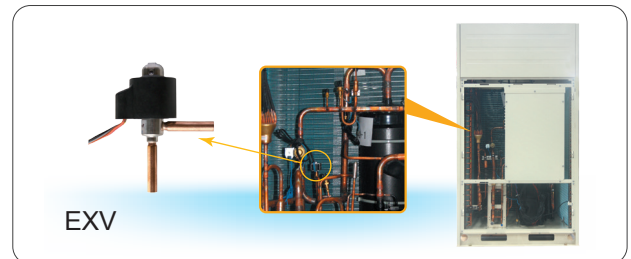

► Precise detection of refrigerant pressure

The high/low pressure sensor is used to monitor the system refrigerant pressure in real time and make sure that the pressure perfectly fit the DC inverter module, thus guaranteeing more stable operation of the unit.



Duty cycling

To ensure the balance between the running duration of compressor and module and the running load, the TIMS allows for cyclic operation of compressors and modules by equally allocating the running duration and load for each compressor and module, so as to make the entire unit/system more durable.



Backup operation

ODU fan, compressor and other parts support emergency operation.

Standby operation function I

When one of the ODU compressors is faulty, the other compressor can start emergency operation.

Standby operation function II

When one of the ODU fans is faulty, the other fan can start emergency operation.

Standby operation function III

For a modular unit, when one of the ODU is faulty, the other ODU can start emergency operation.



Auto snow-blowing function

In case of storms in winter, the ODU can automatically start through the special snow sensor.



Dust-clean function

Upon ODU startup, the fan motor runs reversely to automatically clean the dust from the ODU heat exchanger.





Convenient Application

Provide you convenient services

1100 m

Total pipe length

30%

Approx. 30% less footprint ^{*3}



Wide application range



Auto restart



One-key test run



Easy installation and maintenance



Black box technology



Auto refrigerant charging



Interlocking for hotels



Simple pipe design

Wide application range

► Large-capacity compressor design

TICA 8-22HP units are all equipped with single compressor. The large-capacity single-compressor design makes the system more stable and contributes to larger displacement under the same frequency. The heating performance is improved, especially in low-temperature conditions.



► Wide temperature range

With an ultra-wide operating range of the ODU (cooling: -5°C to $+56^{\circ}\text{C}$; heating: -27°C to $+26^{\circ}\text{C}$), the unit can flexibly respond to the changing outdoor temperature with enhanced stability and applicability.

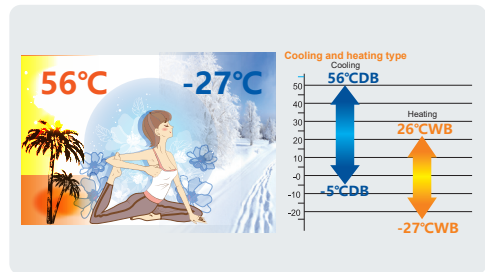

► Wide voltage range

The voltage range for unit running is 310~430V, much wider than the national standard. This can guarantee stable operation of the unit even in areas and during periods with unstable voltage.

► Changeable ESP

Without increasing the noise, blades and DC fan motor that support larger air flow are adopted to achieve a higher external static pressure (up to 110Pa).

The duct can be installed by layers or in a centralized manner. A higher external static pressure can achieve long-distance air supply, so as to effectively avoid loop and short circuit and guarantee excellent ventilation.

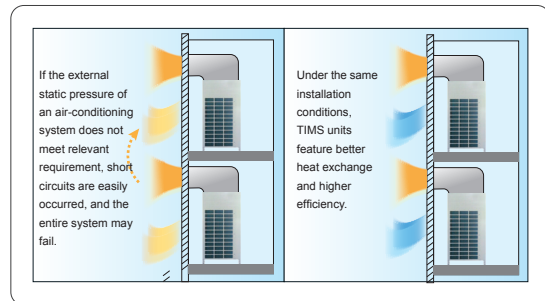
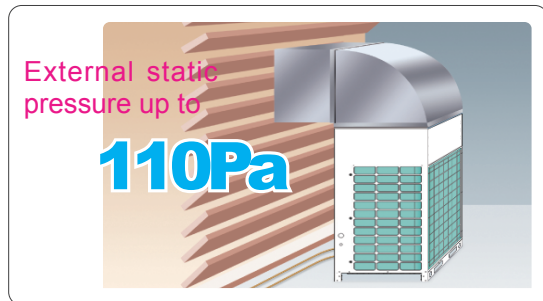

► Long piping capability

Simple design and installation is the basis of quality products. Life featured with simplicity is what the customers need.

Based on top-quality craftsmanship, TICA provides users with professional air-conditioning system solutions and satisfied services. The unit can be flexibly designed and conveniently installed.

- Maximum actual single piping length—200m
- Maximum equivalent single piping length—240m
- Maximum piping (total)—1100m
- Maximum height difference of IDU and ODU—110m
- Maximum height difference of IDUs—30m
- Maximum allowed length pipe after the first branch pipe—90m*



*Check relevant technical documents or consult technicians.

Humanization Design

► Mode control

TICA TIMS VRFs support flexible mode selection (giving priority to the existing operating mode, VIP, cooling/heating, etc.). Through settings on the wired controller, the system prevents unit conflict due to different modes in different rooms in the transition season.

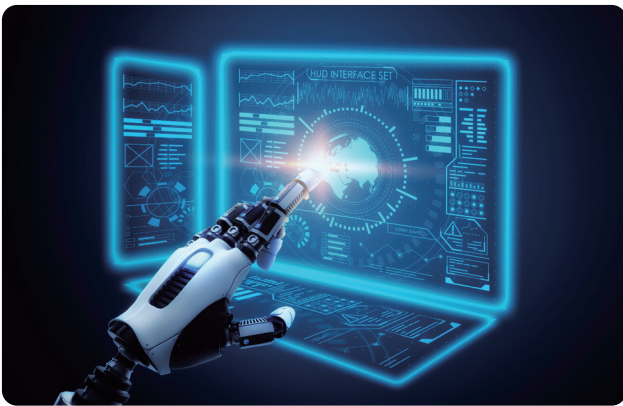

► Cooling / heating priority

In hot summer or cold winter, the cooling/heating priority mode can be selected to implement consistent operation of the VRF product. When the ODU is running in cooling priority mode, the IDU may run in cooling/dry/fan mode only, and heating is unavailable.



► Specified VIP mode

The VIP mode can be enabled to ensure the cooling/heating requirements of certain rooms. When a mode is selected for the VIP IDU, the ODU runs in the same mode, and the mode of other IDUs is determined by the settings on the wired controller in the VIP room.

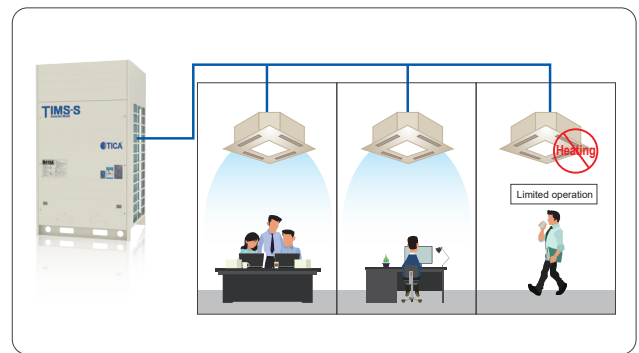

► Auto restart function

The smart system can automatically store the settings in case of long-term power outage. When the power supply is restored, the system will automatically restart (manual start is also supported), and the settings before power outage resume.

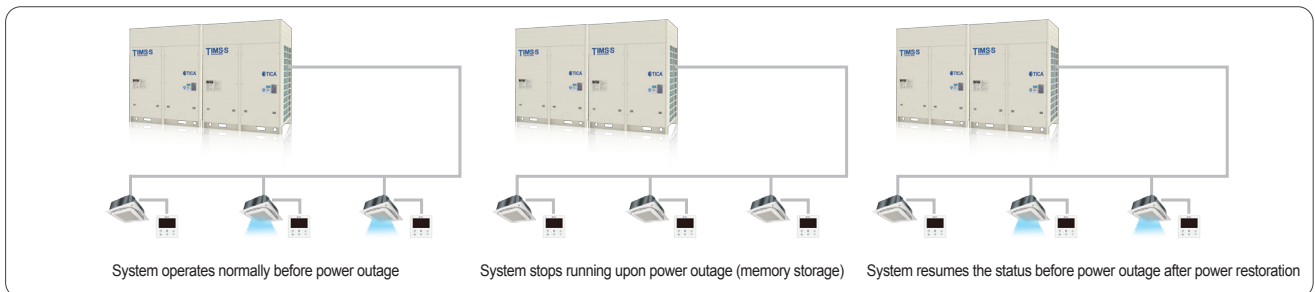

► Auto addressing

The ODU automatically checks the quantity of IDUs and allocates addresses for the IDUs. The installation is simple and convenient.

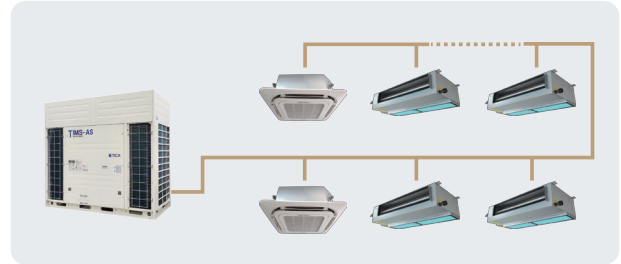

► One-key test run

During commissioning, one-key test run can be carried out at the ODU or IDU side to facilitate on-site commissioning and improve the quality of construction work.

- 1 Auto detection of IDU/ODU power reversion and phase loss
- 2 Auto detection of communication exception between ODU substrate and inverter main board
- 3 Auto detection of IDU-ODU cabling
- 4 Auto detection of operation status of moving parts (such as the compressor, fan motor, EXV, 4-way valve, and solenoid valve)

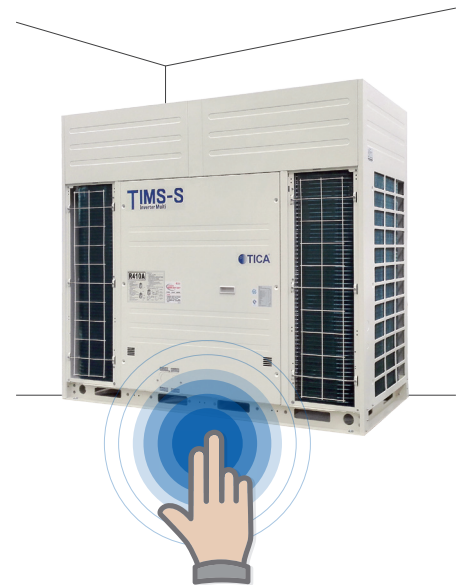

► IDU power-off repair

When an IDU fails and needs to be maintained, it can be powered off separately without affecting the normal operation of the entire system.

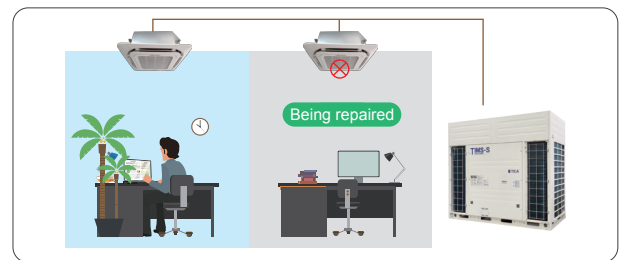

Standard intelligent interlocking for hotels

The specially designed seamless connection interface for hotel door card can be selected in the application scenarios such as hotels. When the door card is inserted, the IDU can be controlled freely; when the door card is removed, the IDU is turned off automatically after a delay, making hotel management convenient and saving power.

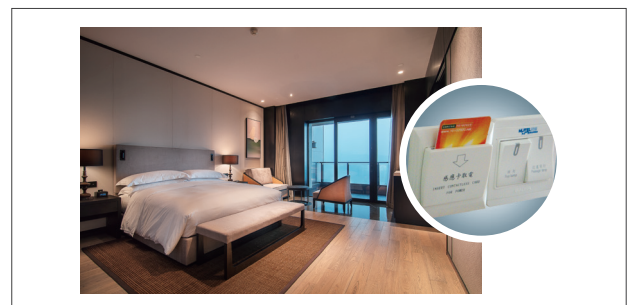

Easy installation and service

► Small footprint, easy to handle

The modular unit features small footprint down to 1.6m². Modules are seamlessly connected to further save the installation space.

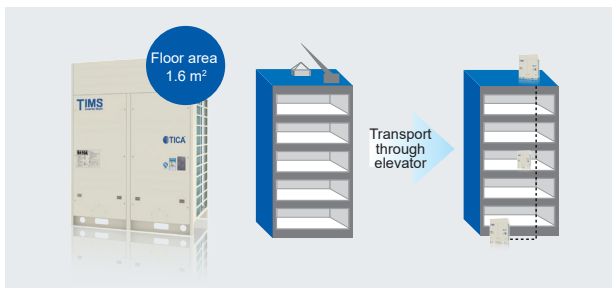

► 360° tube connection

The refrigerant pipe can be connected from the front, left, or right side of the unit. This reduces the construction cost and facilitates the engineering design and installation.



► Non-polarized communication

Non-polarized communication connection is realized between the IDU and the ODU to avoid wrong or opposite connection of wires, greatly simplifying the installation process and expediting the construction period.

► Black box technology

The professional "black box" data saving device is provided to store data related to unit operation for up to ten years. In this way, data can be read conveniently during after-sales maintenance and debugging.

Program upgrade can be intelligently completed by directly inputting the control program to the black box through relevant ports.

► Auto troubleshooting and failure display

The system monitors the unit's real-time running data and displays fault parameters on the wired controller and IDU main board through IDU-ODU communication, to facilitate debugging and repair by after-sales personnel.

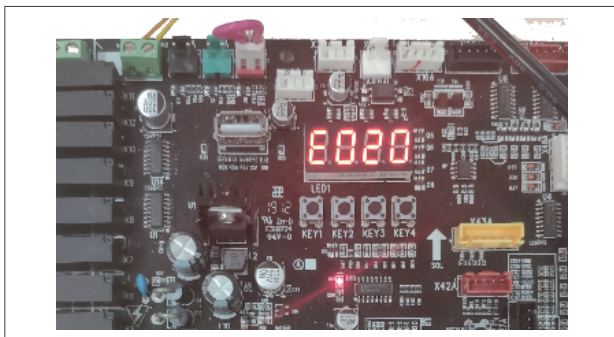

► Auto-repair of electric control circuit

In unfavorable situations such as high temperature, overcurrent, and high/low refrigerant pressure, the system can adjust the unit operation in a timely manner and automatically repair the circuit, so as to ensure that the system operates under proper temperature, current, and refrigerant pressure. This function makes the unit more reliable and durable.

► Easy maintenance

TIMS adopts intelligent control. There is no need for an equipment room, and unattended operation is supported.

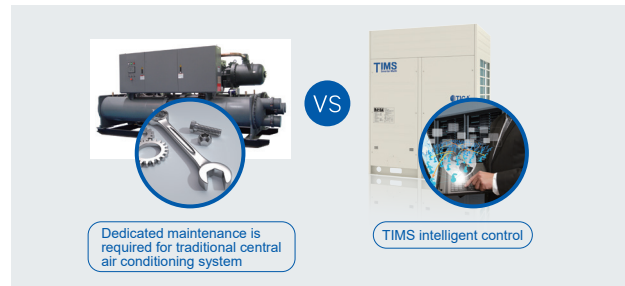

Auto refrigerant charging & recycling

With an advanced intelligent control program, the system can monitor and automatically adjust the refrigerant amount based on the outdoor ambient temperature, the IDU air supply/return temperature, the system super-cooling degree and other relevant factors. In case of insufficient refrigerant in the system or during maintenance, the refrigerant can be conveniently and automatically charged or recycled to the ODU.



Simple design of refrigerant piping

ODU main pipe and IDU branch pipe are selected based on the specifications table. When longer pipes are required, refer to the installation manual.

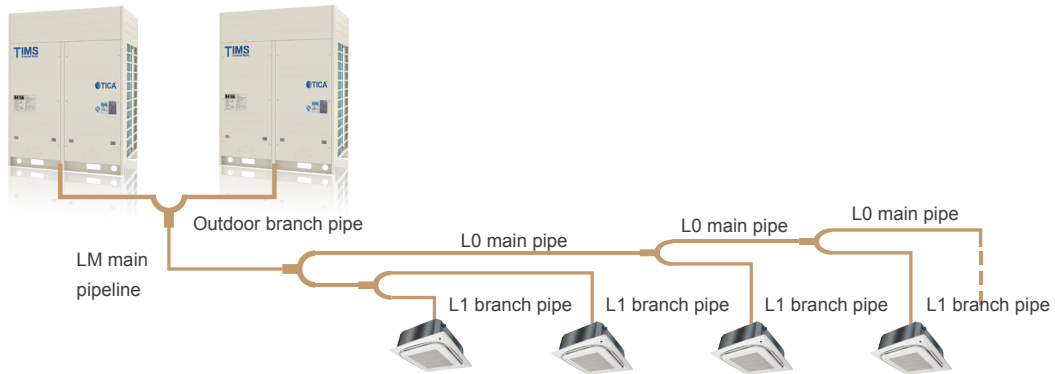

► Main pipeline design for modular series

Total Capacity (kW) of Downstream IDUs	Liquid Pipe Specifications (mm(in))	Gas Pipe Specifications (mm(in))	Branch pipe selection
X<16.8	Φ9.52(3/8")	Φ15.88(5/8")	TBP4022TA
16.8≤X<22.5	Φ9.52(3/8")	Φ19.05(3/4")	TBP4022TA
22.5≤X<33.0	Φ9.52(3/8")	Φ22.23(7/8")	TBP4033TA
33.0≤X<46.0	Φ12.70(1/2")	Φ25.40(1")	TBP4072TA
46.0≤X<67.0	Φ15.88(5/8")	φ28.58(1 1/8")	TBP4072TA
67.0≤X<86.0	Φ19.05(3/4")	φ31.75(1 1/4")	TBP4073TA
86.0≤X<114.0	Φ19.05(3/4")	φ34.92(1 3/8")	TBP4073TA
114.0≤X<140.0	Φ19.05(3/4")	φ38.10(1 1/2")	TBP4073TA
X≥140.0	Φ19.05(3/4")	φ41.30(1 5/8")	TBP4073TA

► Main pipeline design for independent series

Total Capacity (kW) of Downstream IDUs	Liquid pipe specifications (mm(in))	Air pipe specifications (mm(in))	Branch pipe selection
X<16.8	Φ9.52(3/8")	Φ15.88(5/8")	TBP4022TA
16.8≤X<22.5	Φ9.52(3/8")	Φ19.05(3/4")	TBP4022TA
22.5≤X<33.0	Φ9.52(3/8")	Φ22.23(7/8")	TBP4033TA
33.0≤X<46.0	φ12.70(1/2")	Φ25.40(1")	TBP4072TA
46.0≤X<67.0	Φ15.88(5/8")	φ28.58(1 1/8")	TBP4072TA
67.0≤X<86.0	Φ19.05(3/4")	φ31.75(1 1/4")	TBP4073TA
X≥86.0	Φ19.05(3/4")	φ31.75(1 1/4")	TBP4073TA

Specifications

Model		TIMS080CXT	TIMS100CXT	TIMS120CXT	TIMS140CXT	TIMS160CXT	TIMS180CXT	TIMS200CXT	TIMS220CXA	
Horse power	HP	8	10	12	14	16	18	20	22	
Methods of combination		-	-	-	-	-	-	-	-	
Power supply	V/N/Hz	380~415/ 3/50(60)								
Performance	Cooling Operating Range	°C								
	Nominal Cooling Capacity T1 35°C	Ton	7.2	8.0	9.5	11.4	12.8	14.2	15.9	17.5
		kW	25.2	28.0	33.5	40.0	45.0	50.0	56.0	61.5
		Btu/h	86000	95000	114000	136000	153000	170000	191000	209000
	Nominal Cooling Capacity T3 46°C	Ton	5.9	6.8	8.0	9.8	11.0	12.4	13.9	15.3
		kW	20.8	23.9	28.0	34.5	38.7	43.5	48.8	53.7
		Btu/h	70000	81000	95000	117000	132000	148000	166000	183000
	Nominal Cooling Capacity T4 48°C	Ton	5.7	6.6	7.7	9.5	10.7	12.0	13.5	14.9
		kW	20.0	23.2	27.1	33.5	37.6	42.3	47.5	52.3
		Btu/h	68000	79000	92000	114000	128000	144000	162000	178000
	Power Consumption T1 35°C	kW	5.5	6.8	8.7	10.3	12.2	13.9	15.8	18.6
	Power Consumption T3 46°C	kW	6.1	7.1	8.3	10.2	11.2	13.1	14.7	16.6
	Power Consumption T4 48°C	kW	6.2	7.2	8.3	10.1	11.1	12.9	14.6	16.3
	EER T1 35°C	kW/kW	4.58	4.12	3.87	3.88	3.69	3.60	3.55	3.31
	EER T3 46°C	kW/kW	3.41	3.35	3.36	3.39	3.44	3.33	3.31	3.23
	EER T4 48°C	kW/Ton	1.09	1.09	1.08	1.06	1.04	1.07	1.08	1.09
Heating Operating Range	°C									
Heating Capacity	kW	27.0	31.5	37.5	45.0	50.0	56.0	63.0	69.0	
	Btu/h	92000	108000	128000	154000	171000	191000	215000	235000	
Heating Power Consumption	kW	5.4	6.6	8.3	10.3	12.2	13.7	15.5	17.6	
COP	kW/kW	4.99	4.77	4.52	4.38	4.12	4.09	4.06	3.92	
Compressor	Type	Mitsubishi - Inverter Scroll								
	Quantity	1	1	1	1	1	1	1	2	
Fan Motors	Type	Welling DC Inverter								
	Quantity	1	1	1	1	1	1	2	2	
	Max. ESP	Pa	110							
Fan air volume	m³/h	12000			13980			25800		
Net dimensions (W×H×D)	mm	930×860×1710			1240×860×1710			1500×860×1710		
Packed dimensions (W×H×D)	mm	990×920×1770			1300×920×1770			1560×920×1770		
Sound Pressure Level	dB(A)	45~57			45~60	45~61	45~62	63	64	
Refrigerating Piping	Gas Pipe	mm (in)	φ9.52(3/8")		φ12.70(1/2")	φ12.70(1/2")		φ15.88(5/8")		
	Liquid Pipe	mm (in)	φ22.23(7/8")		φ25.40(1")	φ28.58(1 1/8")		φ28.58(1 1/8")		
Net weight	kg	225	225	225	290	290	290	345	380	
Gross weight	kg	240	240	240	305	305	305	360	395	
Refrigerant	Type	R410A								
	Factory charge	kg	8	8	10	12	12	12	16	16
*4 Maximum fuse current	A	20.0	25.0	32.0	40.0	40.0	50.0	50.0	63.0	
*4 Minimum line current	A	17.4	21.7	25.8	33.0	35.0	39.1	43.5	47.5	

Notes:

- The cooling capacity is measured under the following conditions: indoor temperature of 27.0 °C DB/19.5 °C WB ; equivalent refrigerant piping length 10m with zero level difference.
- Fuse or circuit breaker is selected based on MFA. Electrical wiring is selected based on MCA.

Model		TIMS240CXA	TIMS260CXA	TIMS280CXA	TIMS300CXA	TIMS320CXA	TIMS340CXT	TIMS360CXT	
Horse power	HP	24	26	28	30	32	34	36	
Methods of combination		-	-	-	-	-	16+18	18+18	
Power supply	V/N/Hz	380~415/ 3/50(60)							
Performance	Cooling Operating Range	°C							-5~56°C
	Nominal Cooling Capacity T1 35°C	Ton	19.1	20.8	22.3	24.2	25.6	27.0	28.4
		kW	67.0	73.0	78.5	85.0	90.0	95.0	100.0
		Btu/h	228000	249000	267000	290000	307000	324000	341000
	Nominal Cooling Capacity T3 46°C	Ton	16.6	17.9	19.3	20.6	21.9	23.4	24.7
		kW	58.4	62.9	67.9	72.5	77.0	82.2	87.0
		Btu/h	199000	214000	231000	247000	262000	280000	296000
	Nominal Cooling Capacity T4 48°C	Ton	16.2	17.4	18.8	20.0	21.2	22.7	24.1
		kW	56.8	61.2	66.0	70.3	74.7	79.9	84.7
		Btu/h	193000	208000	225000	239000	254000	272000	288000
	Power Consumption T1 35°C	kW	21.0	21.9	21.8	23.0	25.2	26.1	27.8
	Power Consumption T3 46°C	kW	17.9	19.3	19.9	21.0	22.8	24.3	26.1
	Power Consumption T4 48°C	kW	17.4	18.9	19.6	20.6	22.3	24.0	25.8
	EER T1 35°C	kW/kW	3.19	3.34	3.60	3.70	3.57	3.64	3.60
	EER T3 46°C	kW/kW	3.25	3.25	3.41	3.46	3.38	3.38	3.33
	EER T4 48°C	kW/Ton	1.08	1.09	1.04	1.03	1.05	1.06	1.07
Heating Operating Range	°C								-27~26°C
Heating Capacity	kW	75.0	81.5	87.5	95.0	100.0	106.0	112.0	
	Btu/h	256000	278000	299000	324000	341000	362000	382000	
Heating Power Consumption	kW	18.0	19.4	21.3	23.5	24.9	25.6	27.4	
COP	kW/kW	4.17	4.20	4.11	4.04	4.02	4.14	4.09	
Compressor	Type	Mitsubishi -Inverter Scroll							
	Quantity	2	2	2	2	2	2	2	
Fan Motors	Type	Welling DC Inverter							
	Quantity	2	2	2	2	2	2	2	
	Max. ESP	Pa	110						
Fan air volume	m³/h	25800	27000				13980+13980		
Net dimensions (W×H×D)	mm	1500×860×1710	1900×860×1710				(1240+1240)×860×1710		
Packed dimensions (W×H×D)	mm	1560×920×1770	1960×920×1770				(1300+1300)×920×1770		
Sound Pressure Level	dB(A)	64	49~64		49~65		49~65	48~66	
Refrigerating Piping	Gas Pipe	mm (in)	φ15.88(5/8")			φ19.05(3/4")		φ19.05(3/4")	
	Liquid Pipe	mm (in)	φ28.58(1 1/8")			φ31.75(1 1/4")		φ34.92(1 3/8")	
Net weight	kg	380	460	470	470	470	290+290		
Gross weight	kg	395	475	485	485	485	305+305		
Refrigerant	Type	R410A							
	Factory charge	kg	16	18	22	22	22	12+12	
*4 Maximum fuse current	A	63.0	80.0	80.0	80.0	80.0	90.0	100.0	
*4 Minimum line current	A	52.7	66.0	68.0	70.1	72.0	74.1	78.2	

Notes:

- The cooling capacity is measured under the following conditions: indoor temperature of 27.0 °C DB/19.5 °C WB ; equivalent refrigerant piping length 10m with zero level difference.
- Fuse or circuit breaker is selected based on MFA. Electrical wiring is selected based on MCA.

Outdoor Unit

TIMS V6 | Healthy VRF

Model		TIMS380CXT	TIMS400CXT	TIMS420CXA	TIMS440CXA	TIMS460CXA	TIMS480CXA	TIMS500CXA	TIMS520CXA	
Horse power	HP	38	40	42	44	46	48	50	50	
Methods of combination		18+20	20+20	20+22	22+22	24+22	24+24	26+24	26+26	
Power supply	V/N/Hz	380~415/ 3/50(60)								
Performance	Cooling Operating Range	°C								
		-5~56°C								
	Nominal Cooling Capacity T1 35°C	Ton	30.1	31.8	33.4	35.0	36.5	38.1	39.8	41.5
		kW	106.0	112.0	117.5	123.0	128.5	134.0	140.0	146.0
		Btu/h	361000	382000	401000	419000	438000	457000	477000	498000
	Nominal Cooling Capacity T3 46°C	Ton	26.2	27.7	29.1	30.5	31.9	33.2	34.5	35.8
		kW	92.3	97.6	102.5	107.3	112.0	116.7	121.3	125.9
		Btu/h	314000	333000	349000	366000	382000	398000	413000	429000
	Nominal Cooling Capacity T4 48°C	Ton	25.5	27.0	28.4	29.7	31.0	32.3	33.5	34.8
		kW	89.9	95.0	99.8	104.6	109.1	113.7	118.0	122.3
		Btu/h	306000	324000	340000	356000	372000	387000	402000	417000
	Power Consumption T1 35°C	kW	29.67	31.54	34.37	37.20	39.60	42.00	42.85	43.70
	Power Consumption T3 46°C	kW	27.81	29.49	31.37	33.25	34.56	35.86	37.27	38.67
	Power Consumption T4 48°C	kW	27.49	29.13	30.84	32.56	33.67	34.78	36.28	37.78
	EER T1 35°C	kW/kW	3.57	3.55	3.42	3.31	3.24	3.19	3.27	3.34
	EER T3 46°C	kW/kW	3.32	3.31	3.27	3.23	3.24	3.25	3.25	3.25
EER T4 48°C (kw/ton)	kW/Ton	1.08	1.08	1.09	1.09	1.09	1.08	1.08	1.09	
Heating Operating Range	°C		-27~26°C							
Heating Capacity	kW	119.0	126.0	132.0	138.0	144.0	150.0	156.5	162.5	
	Btu/h	406000	430000	451000	471000	491000	512000	534000	555000	
Heating Power Consumption	kW	29.2	30	33.4	35.2	35.6	36	38.9	39.3	
COP	kW/kW	4.08	4.20	3.95	3.92	4.04	4.17	4.02	4.13	
Compressor	Type	Mitsubishi -Inverter Scroll								
	Quantity	2	2	3	4	4	4	4	4	
Fan Motors	Type	Welling DC Inverter								
	Quantity	3	4	4	4	4	4	4	4	
	Max. ESP	Pa	110.00							
Fan air volume	m³/h	13980+25800		25800+25800				25800+27000		
Net dimensions (W×H×D)	mm	(1240+1500)×860×1710		(1500+1500)×860×1710				(1500+1900)×860×1710		
Packed dimensions (W×H×D)	mm	(1300+1560)×920×1770		(1560+1560)×920×1770				(1560+1960)×920×1770		
Sound Pressure Level	dB(A)	48~66			50~67					
Refrigerating Piping	Gas Pipe	mm (in)	φ19.05(3/4")				φ22.23(7/8")			
	Liquid Pipe	mm (in)	φ34.92(1 3/8")				φ38.10(1 1/2")			
Net weight	kg	290+345	345+345	430+380	380+380	380+380	380+380	380+470		
Gross weight	kg	305+360	360+360	445+395	395+395	395+395	395+395	395+485		
Refrigerant	Type	R410A								
	Factory charge	kg	12+16		16+16				16+22	
*4 Maximum fuse current	A	100.0	100.0	113.0	126.0	126.0	126.0	143.0	143.0	
*4 Minimum line current	A	82.6	87.0	91.0	95.0	100.2	105.4	115.5	120.7	

Notes:

1. The cooling capacity is measured under the following conditions: indoor temperature of 27.0 °C DB/19.5 °C WB ; equivalent refrigerant piping length 10m with zero level difference.
2. Fuse or circuit breaker is selected based on MFA. Electrical wiring is selected based on MCA.

Model		TIMS540CXA	TIMS560CXA	TIMS580CXA	TIMS600CXA	TIMS620CXA	TIMS640CXA	TIMS660CXA	
Horse power	HP	54	56	58	60	62	64	66	
Methods of combination		28+26	28+28	30+28	30+30	32+30	32+32	22+22+22	
Power supply		V/N/Hz 380~415/ 3/50(60)							
Performance	Cooling Operating Range	°C -5~56°C							
	Nominal Cooling Capacity T1 35°C	Ton	43.1	44.6	46.5	48.3	49.8	51.2	52.5
		kW	151.5	157.0	163.5	170.0	175.0	180.0	184.5
		Btu/h	517000	535000	558000	580000	597000	614000	629000
	Nominal Cooling Capacity T3 46°C	Ton	37.2	38.6	39.9	41.2	42.5	43.8	45.8
		kW	130.8	135.8	140.4	144.9	149.5	154.0	161.0
		Btu/h	446000	463000	479000	494000	510000	525000	549000
	Nominal Cooling Capacity T4 48°C	Ton	36.2	37.5	38.7	39.9	41.2	42.5	44.6
		kW	127.2	132.0	136.3	140.5	145.0	149.4	156.9
		Btu/h	434000	450000	465000	479000	494000	509000	535000
	Power Consumption T1 35°C	kW	43.65	43.60	44.75	45.90	48.15	50.40	55.80
	Power Consumption T3 46°C	kW	39.22	39.78	40.84	41.91	43.70	45.50	49.88
	Power Consumption T4 48°C	kW	38.44	39.10	40.15	41.20	42.92	44.64	48.84
	EER T1 35°C	kW/kW	3.47	3.60	3.65	3.70	3.63	3.57	3.31
	EER T3 46°C	kW/kW	3.34	3.41	3.44	3.46	3.42	3.38	3.23
EER T4 48°C (kw/ton)	kW/Ton	1.06	1.04	1.04	1.03	1.04	1.05	1.09	
Heating Operating Range	°C -27~26°C								
Heating Capacity	kW	170.0	175.0	182.5	190.0	195.0	200.0	207.0	
	Btu/h	580000	597000	623000	648000	666000	683000	706000	
Heating Power Consumption	kW	41.5	42.6	44.8	47	48.4	49.8	53.4	
COP	kW/kW	4.10	4.11	4.07	4.04	4.03	4.02	3.88	
Compressor	Type	Mitsubishi -Inverter Scroll							
	Quantity	4	4	4	4	4	4	6	
Fan Motors	Type	Welling DC Inverter							
	Quantity	4	4	4	4	4	4	6	
	Max. ESP	Pa	110.00						
Fan air volume	m³/h	25800+27000	27000+27000					25800×3	
Net dimensions (W×H×D)	mm	(1500+1900)×860×1710	(1900+1900)×860×1710					(1500×3)×860×1710	
Packed dimensions (W×H×D)	mm	(1560+1960)×920×1770	(1960+1960)×920×1770					(1560×3)×920×1770	
Sound Pressure Level	dB(A)	50~67	50~68					50~68	
Refrigerating Piping	Gas Pipe	mm (in) φ22.23(7/8")						φ22.23(7/8")	
	Liquid Pipe	mm (in) φ41.30(1 5/8")						φ44.50(1 3/4")	
Net weight	kg	380+470	470+470					380×3	
Gross weight	kg	395+485	485+485					395×3	
Refrigerant	Type	R410A							
	Factory charge	kg	16+22	22+22					16+16+16
*4 Maximum fuse current	A	143.0	160.0	160.0	160.0	160.0	160.0	189.0	
*4 Minimum line current	A	122.8	136.0	138.1	140.2	142.1	144.0	142.5	

Notes:

- The cooling capacity is measured under the following conditions: indoor temperature of 27.0 °C DB/19.5 °C WB ; equivalent refrigerant piping length 10m with zero level difference.
- Fuse or circuit breaker is selected based on MFA. Electrical wiring is selected based on MCA.

Outdoor Unit

TIMS V6 | Healthy VRF

Model		TIMS680CXA	TIMS700CXA	TIMS720CXA	TIMS740CXA	TIMS760CXA	TIMS780CXA	TIMS800CXA	TIMS820CXA	
Horse power	HP	68	70	72	74	76	78	80	82	
Methods of combination		22+22+24	22+24+24	24+24+24	24+24+26	24+26+26	26+26+26	26+26+28	26+26+30	
Power supply		V/N/Hz 380~415/ 3/50(60)								
Performance	Cooling Operating Range	°C -5~56°C								
	Nominal Cooling Capacity T1 35°C	Ton	54.0	55.6	57.2	58.9	60.6	62.3	63.8	65.7
		kW	190	195.5	201	207	213	219	224.5	231
		Btu/h	648000	667000	686000	706000	726000	747000	766000	788000
	Nominal Cooling Capacity T3 46°C	Ton	47.1	48.5	49.8	51.1	52.4	53.7	55.1	56.4
		kW	165.7	170.4	175.1	179.7	184.2	188.8	193.7	198.3
		Btu/h	565000	581000	597000	613000	628000	644000	661000	676000
	Nominal Cooling Capacity T4 48°C	Ton	45.9	47.2	48.5	49.7	50.9	52.2	53.5	54.7
		kW	161.4	166.0	170.5	174.8	179.1	183.5	188.3	192.6
		Btu/h	550000	566000	581000	596000	611000	626000	642000	657000
	Power Consumption T1 35°C	kW	58.20	60.60	63.00	63.85	64.70	65.55	65.50	66.65
	Power Consumption T3 46°C	kW	51.19	52.49	53.79	55.20	56.60	58.00	58.56	59.62
	Power Consumption T4 48°C	kW	49.95	51.06	52.17	53.67	55.17	56.67	57.33	58.38
	EER T1 35°C	kW/kW	3.26	3.23	3.19	3.24	3.29	3.34	3.43	3.47
	EER T3 46°C	kW/kW	3.24	3.25	3.25	3.25	3.25	3.25	3.31	3.33
EER T4 48°C (kw/ton)	kW/Ton	1.09	1.08	1.08	1.08	1.08	1.09	1.07	1.07	
Heating Operating Range	°C	-27~26°C								
Heating Capacity	kW	213.0	219.0	225.0	231.5	238.0	244.5	250.5	258.0	
	Btu/h	362000	362000	362000	362000	362000	362000	362000	362000	
Heating Power Consumption	kW	55.6	53.6	54	55.42	56.84	58.26	58.97	62.34	
COP	kW/kW	3.83	4.09	4.17	4.18	4.19	4.20	4.25	4.14	
Compressor	Type	Mitsubishi -Inverter Scroll								
	Quantity	6	6	6	6	6	6	6	6	
Fan Motors	Type	Welling DC Inverter								
	Quantity	6	6	6	6	6	6	6	6	
	Max. ESP	Pa 110								
Fan air volume	m³/h	25800×3	25800×3	25800×2+27000	25800+27000×2	27000×3				
Net dimensions (W×H×D)	mm	(1500×3)×860×1710	(1500×3)×860×1710	(1500×2+1900)×860×1710	(1500+1900×2)×860×1710	(1900×3)×860×1710				
Packed dimensions (W×H×D)	mm	(1560×3)×920×1770	(1560×3)×920×1770	(1560×2+1960)×920×1770	(1560+1960×2)×920×1770	(1960×3)×920×1770				
Sound Pressure Level	dB(A)	50~68								
Refrigerating Piping	Gas Pipe	mm (in)	φ22.23(7/8")				φ22.23(7/8")		φ25.40(1")	
	Liquid Pipe	mm (in)	φ44.50(1 3/4")				φ44.50(1 3/4")		φ50.80(1 7/8")	
Net weight	kg	380×3	380×3	380×2+460	380+460×2	460×3	460×2+470			
Gross weight	kg	395×3	395×3	395×2+475	395+475×2	475×3	475×2+485			
Refrigerant	Type	R410A								
	Factory charge	kg	16+16+16	16+16+16	16+16+16	16+16+18	16+18+18	18+18+18	18+18+22	
*4 Maximum fuse current	A	189.0	189.0	189.0	206.0	223.0	240.0	240.0	240.0	
*4 Minimum line current	A	147.7	152.9	158.1	171.4	184.7	198.0	200.0	202.1	

Notes:

- The cooling capacity is measured under the following conditions: indoor temperature of 27.0 °C DB/19.5 °C WB ; equivalent refrigerant piping length 10m with zero level difference.
- Fuse or circuit breaker is selected based on MFA. Electrical wiring is selected based on MCA.

Model		TIMS840CXA	TIMS860CXA	TIMS880CXA	TIMS900CXA	TIMS920CXA	TIMS940CXA	TIMS960CXA	
Horse power	HP	84	86	88	90	92	94	96	
Methods of combination		26+26+32	28+28+30	28+30+30	30+30+30	30+30+32	30+32+32	32+32+32	
Power supply	V/N/Hz	380~415/ 3/50(60)							
Performance	Cooling Operating Range	°C							
		-5~56°C							
	Nominal Cooling Capacity T1 35°C	Ton	67.1	68.8	70.7	72.5	73.9	75.3	76.8
		kW	236.0	242.0	248.5	255.0	260.0	265.0	270.0
		Btu/h	805000	825000	848000	870000	887000	904000	921000
	Nominal Cooling Capacity T3 46°C	Ton	57.7	59.2	60.5	61.8	63.1	64.4	65.7
		kW	202.9	208.2	212.8	217.4	221.9	226.5	231.0
		Btu/h	692000	710000	726000	741000	757000	772000	788000
	Nominal Cooling Capacity T4 48°C	Ton	56.0	57.5	58.7	59.9	61.2	62.5	63.7
		kW	197.0	202.3	206.5	210.8	215.2	219.7	224.1
		Btu/h	672000	690000	704000	719000	734000	749000	764000
	Power Consumption T1 35°C	kW	68.90	66.55	67.70	68.85	71.10	73.35	75.60
	Power Consumption T3 46°C	kW	61.42	60.73	61.79	62.86	64.66	66.46	68.26
	Power Consumption T4 48°C	kW	60.10	59.70	60.75	61.80	63.52	65.24	66.96
	EER T1 35°C	kW/kW	3.43	3.64	3.67	3.70	3.66	3.61	3.57
	EER T3 46°C	kW/kW	3.30	3.43	3.44	3.46	3.43	3.41	3.38
EER T4 48°C (kw/ton)	kW/Ton	1.07	1.04	1.03	1.03	1.04	1.04	1.05	
Heating Operating Range	°C								
	-27~26°C								
Heating Capacity	kW	263.0	270.0	277.5	285.0	290.0	295.0	300.0	
	Btu/h	362000	362000	362000	362000	362000	362000	362000	
Heating Power Consumption	kW	63.74	66.1	68.3	70.5	71.9	73.3	74.7	
COP	kW/kW	4.13	4.08	4.06	4.04	4.03	4.02	4.02	
Compressor	Type	Mitsubishi -Inverter Scroll							
	Quantity	6	6	6	6	6	6	6	
Fan Motors	Type	Welling DC Inverter							
	Quantity	6	6	6	6	6	6	6	
Max. ESP	Pa	Welling DC Inverter							
Fan air volume	m³/h	27000×3							
Net dimensions (W×H×D)	mm	(1900×3)×860×1710							
Packed dimensions (W×H×D)	mm	(1960×3)×920×1770							
Sound Pressure Level	dB(A)	50~68							
Refrigerating Piping	Gas Pipe	mm (in)							
	Liquid Pipe	mm (in)							
		φ25.40(1")							
		φ50.80(1 7/8")							
Net weight	kg	460×2+470	470×3	470×3	470×3	470×3	470×3	470×3	
Gross weight	kg	475×2+485	485×3	485×3	485×3	485×3	485×3	485×3	
Refrigerant	Type	R410A							
	Factory charge	kg	18+18+22	22+22+22					
*4 Maximum fuse current	A	240.0	240.0	240.0	240.0	240.0	240.0	240.0	
*4 Minimum line current	A	204.0	206.1	208.2	210.3	212.2	214.1	216.0	

Notes:

- The cooling capacity is measured under the following conditions: indoor temperature of 27.0 °C DB/19.5 °C WB ; equivalent refrigerant piping length 10m with zero level difference.
- Fuse or circuit breaker is selected based on MFA. Electrical wiring is selected based on MCA.

MINI VRF

- **Ultra Quiet Operation**
- **Superior Technologies**
- **Mini VRF specification**

Ultra Quiet Operation

Advanced Silent Technologies

The scroll heating series adopt the all-round noise-reducing technology and newly-designed fan blade to reduce the airflow noise through the smooth suction structure, and the compressor noise isolation technology to implement ultra-silent operation, creating a high-quality and comfortable environment.

Newly-designed fan air duct with the streamlined distribution of the air discharge grilles can reduce the wind resistance and noise.

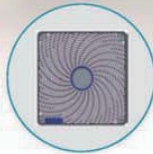

The PET (macromolecule acupuncture cotton), which is the kind of cotton specially used by high-speed railway to isolate noise, perfectly absorbs noises of all frequency bands.



CFD analogue simulation, together with the new fan blade, and the 4-blade axial flow design guarantee a better heat-exchanging performance and lower noise.



The DC brushless motor features stepless speed adjustment and more stable operation, achieving higher energy efficiency and reducing noises.

The 180° sine wave control technology applied to the compressor ensures the smooth and stable operation of compressor and effectively inhibits the abnormal noise during operation.

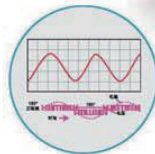

Advanced reactor can completely eliminate electromagnetic noise.



The compressor noise enclosure effectively avoids the proliferation of compressor noise.

Smart Night Silent Mode

The system adopts the delay judgment mode based on the outdoor ambient temperature peak. Meanwhile, it will automatically determine whether to enter the night silent mode according to the current ambient temperature and load size. The minimum noise of silent operation can be as lower as 45 dB (A).

Forced Silent Mode

For supporting projects of high-rise buildings or sites with a stricter silent requirement, users can select the forced silent operation mode as required to reduce the operation noise of the unit and create a more quiet and comfortable environment.

Night Forced Silent Mode

For a higher requirements of quietness and higher requirements for silent mode at night, the night forced silent mode provides a more quiet environment under a variety of conditions.

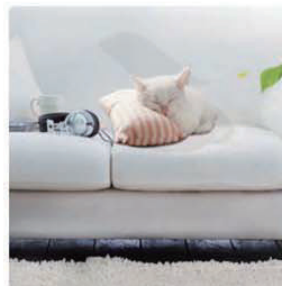

Superior Technologies

Are you looking for a cozy room with less electricity used?

All DC Compliant Enhanced Vapor Injection Scroll Compressor

Three Core Technologies for Excellent Performance

Floating sealing ring technology improves compressor's starting performance

Patented enhanced vapor injection (EVI) technology

High-efficiency centralized stator winding improves motor rated efficiency to > 95%

3.4 mm-thick casing design

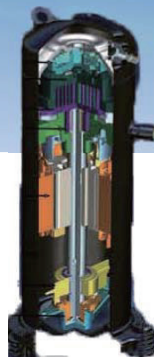

Variable volume ratio scroll technology substantially improves energy efficiency of compressor with low pressure ratio

6-pole permanent magnet motor
Stable operation with 900–7200 RPM

Oil duct reduces oil circulation rate when compressor is working at high speed

Volumetric oil pump
Oil pumped does not vary with oil level.

● All DC Inverter Technology

The secret of high energy efficiency

All DC inverter compressor, the core source of power, is equipped with a 6-pole high-efficiency motor, and the enhancement of part load efficiency is tailored to better suit the operations of low ambient temperature heating units.

6-pole reluctance-type DC motor

4-pole



6-pole



50% increase in magnetic force
Higher shaft rotating efficiency

● Wide voltage range

The all DC inverter system starts flexibly, with the rotating speed of the compressor increasing steadily, the current rising slowly, and small impact on the power grid. Even under the condition of 160 V ultra-low voltage or 260 V ultra-high voltage, the system can still start and operate normally, and provide comfortable heating service.

VS

The fixed speed system starts the compressor instantly. The startup current of up to 6–7 times of the operating current may result in a sharp drop in power supply voltage, and lead to a failure of unit startup and the even more serious problems during peak periods.

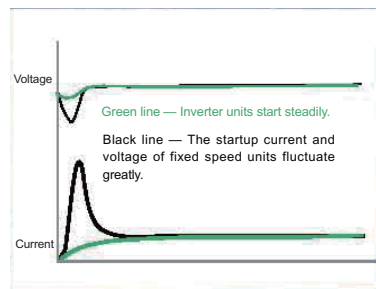

● Wide temperature range

Enhanced Vapor Injection Technology — Strong Heating Capability Without Electric Auxiliary

Just like the difference between turbo supercharging and normal aspiration (2.0 T = 3.0 L)

The world's most advanced technology for heat pump system dealing with low-temperature heating

The whole series adopt the high-efficiency EVI system and the new variable-frequency control and refrigerant system of TICA, achieving excellent heating performance even at the ultra-low temperature of -30°C . The heating capability is increased by over 45% and won't subside at -20°C . In hot summer, the cooling capability won't decrease even at 43°C , assuring you a cool summer indoors.





● **Compact design**

TICA scroll heating series of household central air conditioner feature a compact design with a single fan and three-layer high-efficiency and high-quality heat exchanger. With a mini body, they can be easily installed in a small space such as a bay window, optimizing the spatial pattern and making your home more beautiful and fashionable.



● **Intelligent Defrosting**

The patented smart vapor injection defrosting technology of TICA can increase the refrigerant circulation flow during defrosting, which will shorten the defrosting time, reduce the cold air felt by customers during defrosting, improve the defrosting efficiency, and cut down the power consumption.

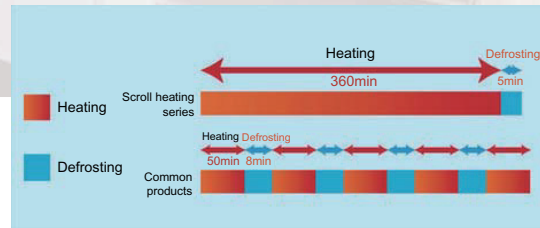

● **Oil Return On Heating Operation Without Shutdown**

Traditional units have to be turned off to achieve oil return, while TICA scroll heating series of household VRF units can implement heating without switching the direction of the refrigerant flow. This series adopt the modes of on-demand oil return and high/low frequency switchover oil return to prevent wild fluctuation of indoor temperature, and provide user with more comfortable experience.



Maximum actual length of single pipe	50m
Maximum equivalent length of single pipe	75m
Maximum total equivalent pipe length	100m
Maximum drop of indoor/outdoor unit	30m
Maximum drop of indoor unit	8m
Maximum permitted length after first branch	15m*

* Pls consult the detailed technical documentation or other matters with the relative technicians.

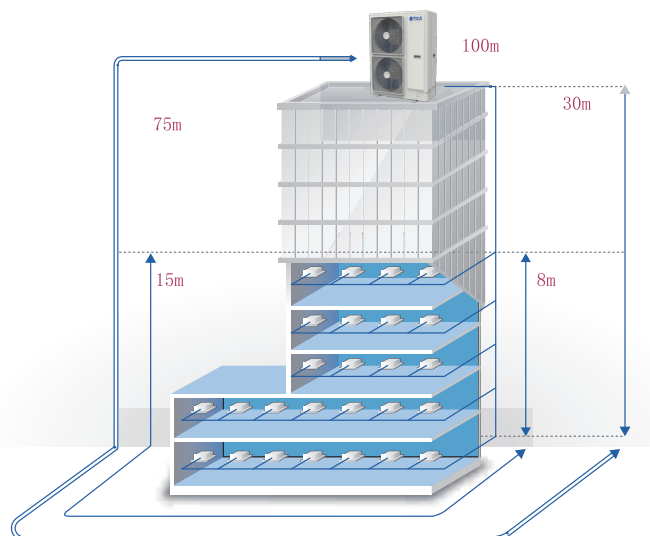

Smart Home

Technology-driven intelligence for smarter life, be a real air conditioning messenger.





Mini VRF specification (High-efficiency series)

Model (TIMS-XX-AHT)			100	125	140	160	180	TIMS180AHTA	
Power supply		V/N/Hz	220-240 / 1 / 50(60)					380-415 / 3 / 50(60)	
*1 Cooling	Capacity	kW	10.0	12.5	14.0	16.0	18.0	18.0	
	Power input	kW	2.9	3.1	3.8	4.7	5.4	5.4	
	EER	/	3.4	4.0	3.7	3.4	3.3	3.3	
*2 Heating	Capacity	kW	12.5	14.0	16.0	18.0	20.0	20.0	
	Power input	kW	3.0	3.2	4.1	4.5	5.3	5.3	
	COP	/	4.2	4.4	3.9	4.0	3.8	3.8	
Connectable indoor unit	Total capacity	kW	50%-130% of outdoor unit capacity						
	Max. quantity	/	5	6	7	8	9	10	
Compressors	Type	/	DC inverter						
	Quantity	/	1	1	1	1	1	1	
Fan motors	Type	/	DC						
	Quantity	/	1	1	1	1	2	2	
	Max.ESP	Pa	50.0	50.0	50.0	50.0	50.0	50.0	
Airflow rate		m ³ /h	4800	6000	6000	6000	6600	6600	
Net dimensions (W*D*H)		mm	980×390×850				980×390×1260		
Packed dimensions (W*D*H)		mm	1040×450×910				1040×450×1320		
Sound pressure level	Cooling/Heating	dB(A)	50/54	50/55	52/55	53/56	59/62	59/62	
Pipe connections	Liquid pipe	mm(in)	φ9.52(3/8")				φ9.52(3/8")		
	Gas pipe	mm(in)	φ15.88(5/8")				φ19.05(3/4")		
Net weight		kg	85	85	85	85	120	115	
Gross weight		kg	95	96	96	96	131	126	
Refrigerant	Type	/	R410A						
	Factory charge	kg	3.5	3.5	4.0	4.0	4.0	4.0	
Operating temperature range	Cooling	°C	-5~54°C						
	Heating	°C	-25~27°C						
*3 Maximum fuse current	MFA	A	40.0	40.0	40.0	40.0	40.0	16.0	
*3 Minimum line current	MCA	A	32.0	32.0	32.0	32.0	36.0	13.5	

Notes:

- The cooling capacity is measured under the following conditions: indoor temperature of 27.0 °C DB/19.5 °C WB ; outdoor temperature of 35.0 °C DB; equivalent refrigerant piping length 10m with zero level difference.
- Fuse or circuit breaker is selected based on MFA. Electrical wiring is selected based on MCA.



Mini VRF specification (Classic series)

Model (TIMS-XX-AHR)			080	100	112	125	140	160	TIMS200CHRA	TIMS224CHRA	
Power supply		V/N/Hz	220-240 / 1 / 50(60)						380-415 / 3 / 50(60)		
*1 Cooling	Capacity	kW	8	10	11.2	12.5	14.0	16	20	22.4	
	Power input	kW	2.5	3.0	3.0	3.6	4.1	5.1	6.6	7.2	
	EER	/	3.2	3.3	3.7	3.7	3.4	3.7	3.0	3.1	
*2 Heating	Capacity	kW	9.0	11.5	12.5	13.5	16.0	17.0	22.4	25	
	Power input	kW	2.4	2.9	3.6	3.5	4.0	4.9	6	6.7	
	COP	/	3.8	4.0	3.5	3.7	4.0	3.7	3.7	3.7	
Connectable indoor unit	Total capacity	kW	50%-130% of outdoor unit capacity								
	Max. quantity	/	4	4	6	6	7	8	10	10	
Compressors	Type	/	DC inverter								
	Quantity	/	1	1	1	1	1	1	1	1	
Fan motors	Type	/	DC								
	Quantity	/	1	1	1	1	1	1	2	2	
	Max.ESP	Pa	30	30	50	50	50	50	50	50	
Airflow rate	m ³ /h		3300	4800	5400	5400	6000	6000	7200	7200	
Net dimensions (W*D*H)	mm		980×390×850						980×390×1260		
Packed dimensions (W*D*H)	mm		1040×450×910						1040×450×1320		
Sound pressure level	Cooling/ Heating	dB (A)	50/53	50/54	50/55	50/55	52/56	53/56	56/59	56/59	
Pipe connections	Liquid pipe	mm(in)	φ9.52(3/8")						φ9.52(3/8")		
	Gas pipe	mm(in)	φ15.88(5/8")						φ19.05(3/4")		
Net weight	kg		58	74	78	78	84	84	125	125	
Gross weight	kg		68	84	89	89	95	95	136	136	
Refrigerant	Type	/	R410A								
	Factory charge	kg	2.15	2.15	3.3	3.3	3.8	3.8	5.6	5.6	
Operating temperature range	Cooling	°C	-5~54°C								
	Heating	°C	-25~27°C								
*3 Maximum fuse current	MFA	A	20.0	20.0	40.0	40.0	40.0	40.0	20.0	20.0	
*3 Minimum line current	MCA	A	16.0	16.0	32.0	32.0	32.0	32.0	17.0	17.0	

Notes:

- The cooling capacity is measured under the following conditions: indoor temperature of 27.0 °C DB/19.5 °C WB ; outdoor temperature of 35.0 °C DB; equivalent refrigerant piping length 10m with zero level difference.
- Fuse or circuit breaker is selected based on MFA. Electrical wiring is selected based on MCA.

Indoor unit



IDUs

ABUNDANT INDOOR UNITS LINEUP

TICA boasts 12 series of VRF IDUs, covering all major IDU types in the market and can meet the diversified requirements of users. All TICA VRF IDUs are not equipped with electric heaters to ensure safe and energy saving operations and enhanced comfort.



Round flow cassette

- Streamlined panels in uniform size
- 360° three-dimensional air supply
- 230mm ultra-thin body
- Condensate water lift pump (standard)
- PM2.5 and formaldehyde filters (optional)



Two-way cassette

- Two-way air supply
- 3.5m ceiling air supply
- Condensate water lift pump (standard)



One-way cassette

- Super-wide air supply
- 10-65° wide air supply outlet



High static pressure duct

- Up to 200Pa external high static pressure
- Intake fresh air
- Low noise operation



High static pressure duct

- Patented labyrinth box structure with air leakage rate as low as 0.029%
- 300Pa ultra-high static pressure, suitable for large spaces with high ceiling
- Robust double-wall design eliminating cold bridge condensate

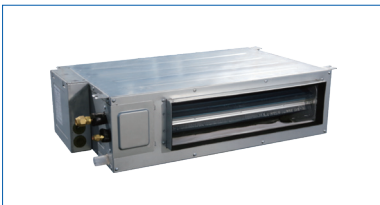

Slim duct

- 200mm ultra-thin body
- Ultra-silent design
- Condensate water lift pump (standard)



DC slim duct

- 200mm ultra-thin body
- DC motor
- Condensate water lift pump (standard)



Medium static pressure duct

- DC motor
- V-shaped heat exchanger
- Seven fan speeds available
- Condensate water lift pump (standard)



All fresh air duct

- Intake fresh air
- 300Pa ultra-high static pressure
- Applicable to large spaces



Wall mounted

- Streamlined design with elegant appearance
- Double-layer auto swing
- Removable air return panel



Ceiling & Floor

- Auto wide-range air supply
- Single-side simple and convenient maintenance

Round flow cassette

Application scenario: supermarket, restaurant, shop lobby, etc.

Model

28 36 45 50 56 63 71 80

90 100 112 125 140 160



Streamlined panels in uniform size, elegant and generous
Newly designed streamlined panel, stylish and elegant.

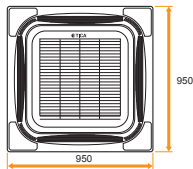

Unique PM2.5 and formaldehyde purification and antibacterial solutions

PM2.5, formaldehyde and antibacterial filters are provided to provide a super-clean indoor environment.

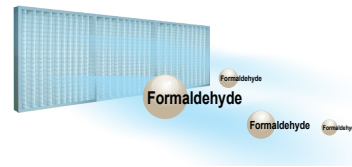

360° three-dimensional air supply with more uniform air flow

360° three-dimensional air supply design features more reasonable airflow distribution and more uniform temperature in the entire room for improved comfort.

360°
The air flow can reach every corner of the room



Air flow from ceiling to ground

The air supply is not limited by the floor height. The cold air can reach the ground in a room of up to 3.5 m high to achieve optimum air conditioning performance.

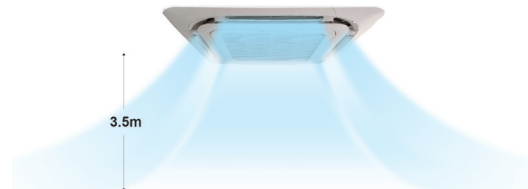

Ultra-thin body requiring smaller installation space

The ultra-thin (230 mm) body of the unit satisfies the space requirement of narrow ceiling space. Installation is not limited by the room space. Flexible decoration combination makes easier installation.

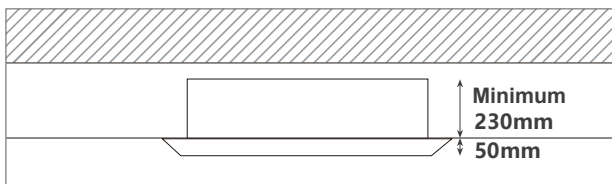

High-lift Pump Providing Smoother Drainage

Built-in with a fully-automatic drain pump. Pumping head is up to 1200 mm, flexible for drainage pipe design.

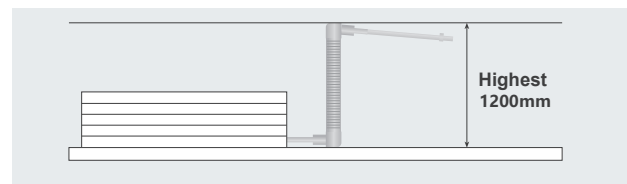

Silent operation creating a comfortable and quiet world

The use of aerospace technology on 3D spiral fan blades with optimized air duct design reduces internal resistance of the unit and achieves ultra-quiet operation, creating a comfortable and pleasant environment.

DC type for enhanced energy efficiency (optional)

DC brushless motor of leading brand is adopted for more silent and efficient operation.

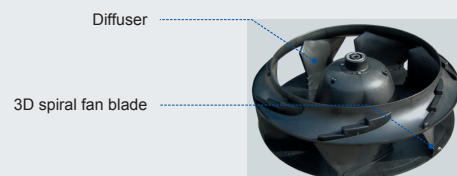

Specifications

Round flow cassette

Model (TMCF-XX-AB)		028	036	045	050	056	063	071	080	090	100	112	125	140	160	
Nominal cooling capacity	kW	2.8	3.6	4.5	5.0	5.6	6.3	7.1	8.0	9.0	10.0	11.2	12.5	14.0	16.0	
Nominal heating capacity	kW	3.2	4.0	5.0	5.6	6.3	7.1	8.0	9.0	10.0	11.2	12.5	14.0	16.0	18.0	
Power supply	V/N/Hz	220/1/50														
Nominal input power	W	55	55	70	70	75	75	90	90	150	150	150	190	190	210	
Dimensions (W×D×H)	mm	840X840X230							840X840X300							
Panel dimensions (W×D×H)	mm	950X950X50														
Panel color		Milky white														
Air flow	m ³ /h	750	810	900	900	960	960	1020	1200	1500	1620	1700	1800	1800	2100	
Sound pressure level	dB(A)	32		36				39		42			44		44	
Weight	kg	22.5	22.5	24.5	24.5	24.5	24.5	24.5	24.5	29.5	29.5	29.5	29.5	32	32	
Connection pipe size	Liquid pipe	mm(in)	φ6.35(1/4")						φ9.52(3/8")							
	Gas pipe	mm(in)	φ12.70(1/2")						φ15.88(5/8")							
	Condensate drain pipe	mm	DN25													

DC round flow cassette

Model (TMCX-XX-ABB)		028	036	045	050	056	063	071	080	090	100	112	125	140	160	
Nominal cooling capacity	kW	2.8	3.6	4.5	5.0	5.6	6.3	7.1	8.0	9.0	10.0	11.2	12.5	14.0	16.0	
Nominal heating capacity	kW	3.2	4.0	5.0	5.6	6.3	7.1	8.0	9.0	10.0	11.2	12.5	14.0	16.0	18.0	
Power supply	V/N/Hz	220/1/50														
Nominal input power	W	36	36	45	45	45	45	73	73	67	67	88	88	88	130	
Dimensions (W×D×H)	mm	840X840X230							840X840X300							
Panel dimensions (W×D×H)	mm	950X950X50														
Panel color		Milky white														
Air flow	m ³ /h	810	810	960	960	960	960	1020	1020	1500	1500	1800	1800	1800	2100	
Sound pressure level	dB(A)	32		36				39		42			44		44	
Weight	kg	22.5	22.5	24.5	24.5	24.5	24.5	24.5	24.5	29.5	29.5	29.5	29.5	32	32	
Connection pipe size	Liquid pipe	mm(in)	φ6.35(1/4")						φ9.52(3/8")							
	Gas pipe	mm(in)	φ12.70(1/2")						φ15.88(5/8")							
	Condensate drain pipe	mm	DN25													

Compact Round Flow Cassette

Model (TMCf-XX-AC)		015	022	028	036	045	050
Nominal cooling capacity	kW	1.5	2.2	2.8	3.6	4.5	5.0
Nominal heating capacity	kW	2.2	2.5	3.2	4.0	5.0	5.6
Power supply	V/N/Hz	220/1/50					
Nominal input power	kW	0.05	0.05	0.05	0.075	0.075	0.075
Dimension(W×D×H)	mm	590X590X260					
Panel Dimension(W×D×H)	mm	680X680X30					
Panel color		Milky white					
Air flow	m ³ /h	500	500	500	680	680	680
Sound pressure level	dB(A)	36	36	36	42	42	42
Weight	kg	16/20	16/20	16/20	18/22	18/22	18/22
Connection pipe size	Liquid pipe	mm(in)	φ6.35(1/4")				
	Gas pipe	mm(in)	φ12.70(1/2")				
	Condensate drain pipe	mm	DN25				

Two-way cassette

Application scenario: corridor, living room, dining room, and other long and narrow places

Model

28 36 45 50 56 71 80



Two-way air supply, perfectly adapt to long and narrow rooms

Two-way air supply is applicable to long and narrow rooms and corridors. Only the air supply/return outlet is exposed, contributing to an elegant appearance.



Ultra-thin design for easy mounting

Ultra-thin body can be easily installed in rooms with various storey heights to match the indoor decoration.

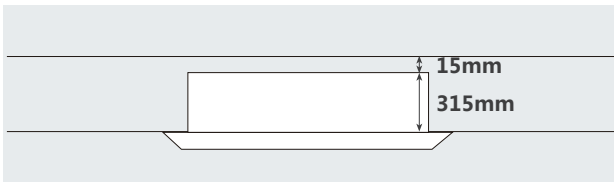

High-lift Pump Providing Smoother Drainage

Built-in with a fully-automatic drain pump. Pumping head is up to 1200mm, flexible for drainage pipe design.

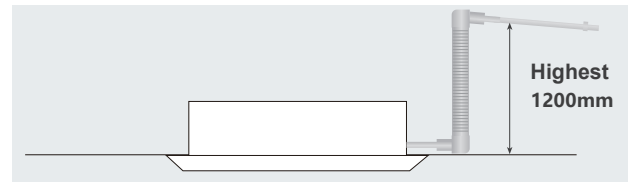

Quiet air conditioning environment

The compact turbo fan adopts axial air intaking. Small blades ensure even air supply and substantially reduce noise for a quiet and comfort environment.



Air flow from ceiling to ground

The air supply is not limited by the floor height. The cold air can reach the ground in a room of up to 3.5 m high to achieve optimum air conditioning performance.

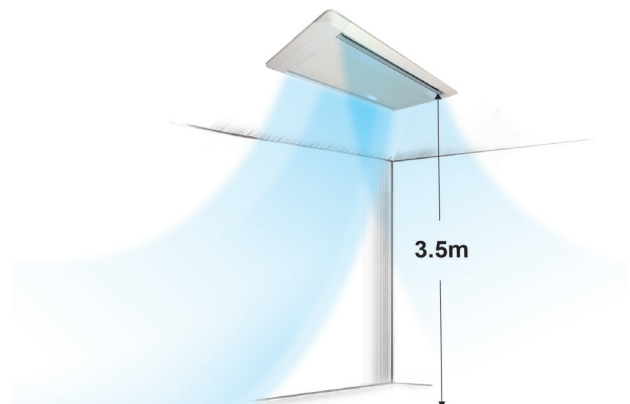

Exclusive sterilizing filter

The unique sterilizing filter can effectively filter smog and dust from air, to provide users with fresh air all the time.

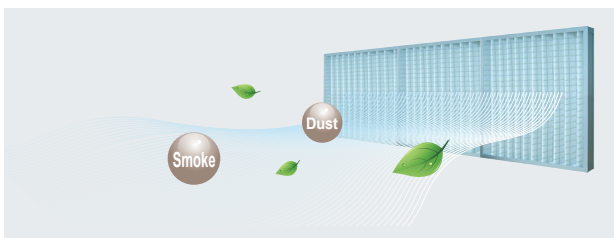

Specifications

Two-way cassette

Model (TMCD-XX-A)		028	036	045	056	071	080	
Nominal cooling capacity	kW	2.8	3.6	4.5	5.6	7.1	8.0	
Nominal heating capacity	kW	3.2	4.0	5.0	6.3	8.0	9.0	
Power supply	V/N/Hz	220/1/50						
Nominal input power	W	60	62	68	85	94	98	
Dimensions (W×D×H)	mm	970x520x315		970x520x315		1210x520x315		
Panel dimensions (W×D×H)	mm	1176x630x33		1176x630x33		1416x630x33		
Panel color		Milky white						
Air flow	m ³ /h	500	616	773	900	1165	1300	
Sound pressure level	dB(A)	37	39	43	45	47	49	
Weight	kg	32	32	37	37	40	40	
Connection pipe size	Liquid pipe	mm(in)	φ6.35(1/4")				φ9.52(3/8")	
	Gas pipe	mm(in)	φ12.70(1/2")				φ15.88(5/8")	
	Condensate drain pipe	mm	DN20					

One-way cassette

Application scenario: corridor, living room, dining room, and other long and narrow places

Model

28 36 45 56 71



Super-wide air supply, suitable for corridors and corners

Swing motor system of new model may provide up/down swing and left/right swing to realize super-wide air supply and greatly enlarge the comfortable zone.

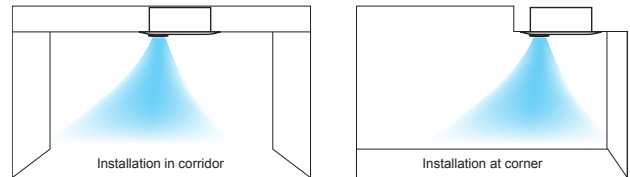

Exclusive sterilizing filter

The unique sterilizing filter can effectively filter smog and dust from air, to provide users with fresh air all the time.

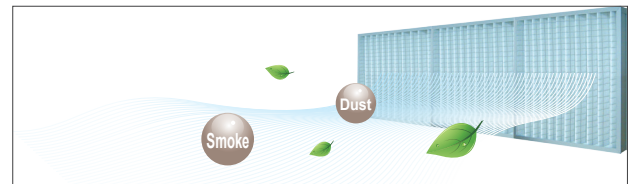

Wide air supply outlet providing a comfortable and pleasant environment

Fan deflector may provide wide range air supply of 10-65°, creating cozy living environment indoors and comfortable feeling of wide angle

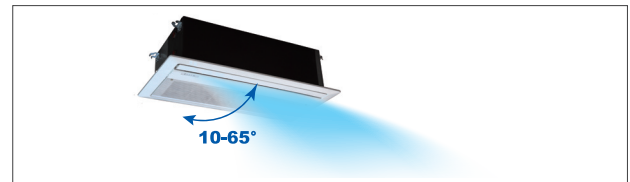

Quiet air conditioning environment

The compact turbo fan adopts axial air intaking. Small blades ensure even air supply and substantially reduce noise for a quiet and comfort environment.



High-lift Pump Providing Smoother Drainage

Built-in with a fully-automatic drain pump. Pumping head is up to 1200mm, flexible for drainage pipe design.

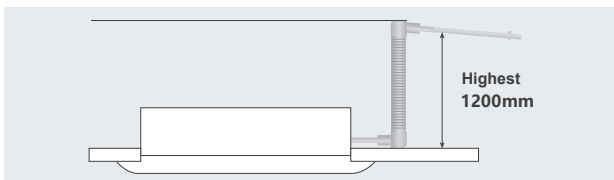

Ultra-thin design for easy mounting

Ultra-thin body with the thickness of only 250 mm installed in a concealed way to lift the height of the suspended ceiling, especially suitable for ceilings with narrow height of suspended ceilings

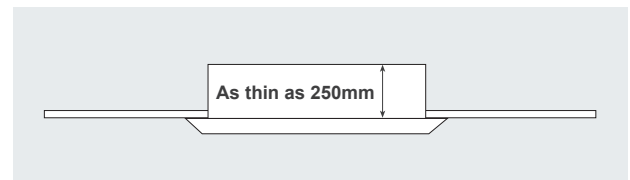

Specifications

One-way cassette

Model (TMCS-XX-A)		028	036	045	056	071
Nominal cooling capacity	kW	2.8	3.6	4.5	5.6	7.1
Nominal heating capacity	kW	3.2	4.0	5.0	6.3	8.0
Power supply	V/N/Hz	220/1/50				
Nominal input power	W	40	40	45	45	50
Dimensions (W×D×H)	mm	870x460x250			1180x495x290	
Panel dimensions (W×D×H)	mm	1070x520x33			1380x550x33	
Panel color		Milky white				
Air flow	m ³ /h	510	600	720	910	1000
Sound pressure level	dB(A)	36	38	42	45	47
Weight	kg	25	27	27	39	39
Connecting pipe Dimensions	Liquid pipe	mm(in)	φ6.35(1/4")			φ9.52(3/8")
	Gas pipe	mm(in)	φ12.70(1/2")			φ15.88(5/8")
	Condensate drain pipe	mm	DN20			

Medium static pressure duct

Application scenario: supermarket, shop, office building, and other large spaces

Model

80 90 100 112 125 140 160

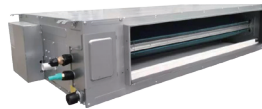

Ultra-thin design for less footprint

Ultra-thin body with the thickness of only 270mm installed in a concealed way to lift the height of the suspended ceiling, especially suitable for ceilings with narrow height of suspended ceilings.

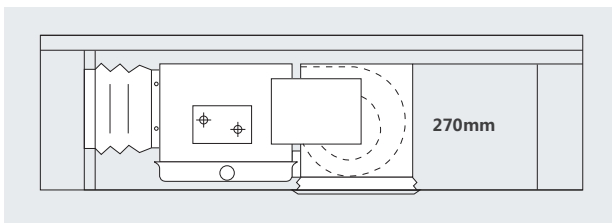

Condensate water lift pump

The automatic condensate water lift pump is adopted for smoother drainage, with the drainage height highest to 1200 mm.



Brushless DC motor for comfort and efficiency

Acclaimed brushless DC motor free of excitation loss and carbon brush loss, with the energy efficiency 30% higher than AC motor.



Seven fan speeds, up to 100Pa static pressure

Multiple noise reduction measures and seven fan speeds can achieve low-noise operation for a quieter environment (as low as 33dB(A)).

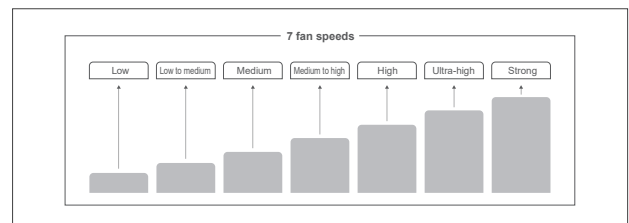

Ultra-quiet operation

The fan motor of delicate and compact design equipped with brand-new propeller housing with vibration absorption function delivering operating noise as low as 33dB(A) to satisfy rigorous noise requirements at different sites.

20 dB(A)	30 dB(A)	40 dB(A)	50 dB(A)
Rustle of the leaves	Quiet study room	Quiet recording studio	Working office

Unique PM2.5 and formaldehyde purification and antibacterial solutions

PM2.5, formaldehyde and antibacterial filters are to provide super-clean indoor environment.



Specifications

Medium static pressure duct

Model (TMDN-XX-AE)		080	090	100	112	125	140	160
Nominal cooling capacity	kW	8.0	9.0	10.0	11.2	12.5	14.0	16.0
Nominal heating capacity	kW	9.0	10.0	11.2	12.5	14.0	16.0	18.0
Power supply	V/N/Hz	220/1/50						
Nominal input power	W	130	130	160	160	160	200	200
Dimensions (W×D×H)	mm	1200×680×270						
Air flow	m ³ /h	1300	1300	1600	1600	1600	2000	2000
ESP (adjustable)	Pa	30 - 100	30 - 100	30 - 100	30 - 100	30 - 100	30 - 100	30 - 100
Sound pressure level	dB(A)	40	40	43	43	43	43	43
Weight	kg	34.5	34.5	37	37	37	38	38
Connection pipe size	Liquid pipe	mm(in)	φ9.52(3/8")					
	Gas pipe	mm(in)	φ15.88(5/8")					
	Condensate drain pipe	mm	DN25					

Slim duct

Application scenario: bedroom, living room, office, etc.

Model

22	25	28	32	36	40	45	50
56	63	71					

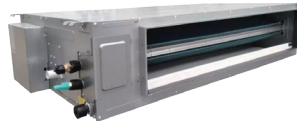

Smart and compact design

Designed with 200 mm thickness, the body is lighter and the installation space required is smaller, making it suitable for more small spaces.

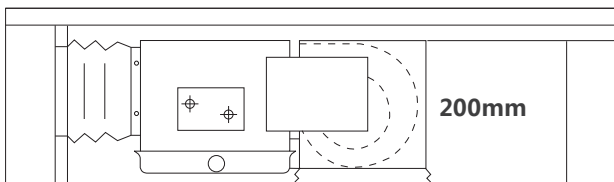

Diversified air return mode featuring flexibility and convenience

The air the return plenum as standard configuration may change air return mode based on the actual circumstances at the site to enable more flexible air return.

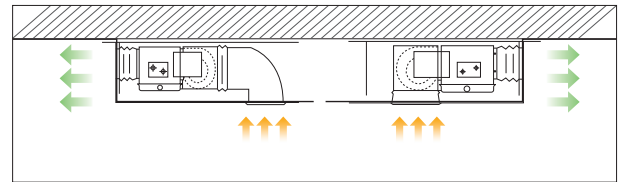

Ultra-silent design leading a quiet life

Use the brand-new CFD optimized duct and simulated fan blades to ensure softer air supply, and the auxiliary streamlined embedded foam Wiring drain pan lowers noise of eddy current to 23 dB, equal to the normal human breathing sound, bringing you a naturally quiet home.

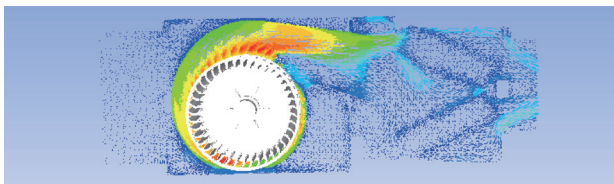

Condensate water lift pump

The automatic condensate water lift pump is adopted for smoother drainage, with the drainage height highest to 1200 mm.

The left and right drainage methods are available.

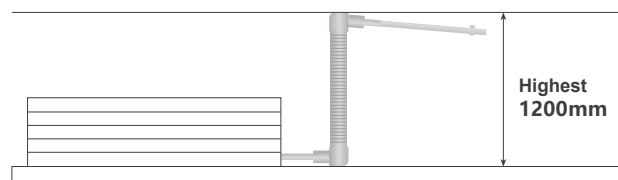

DC type for enhanced energy efficiency (optional)

DC brushless motor of leading brand is adopted for more silent and efficient operation.

Unique PM2.5 and formaldehyde purification and antibacterial solutions

PM2.5, formaldehyde and antibacterial filters are to provide super-clean indoor environment.



Specifications

Slim duct

Model (TMDN-XX-AC)		022	025	028	032	036	040	045	050	056	063	071	
Nominal cooling capacity	kW	2.2	2.5	2.8	3.2	3.6	4.0	4.5	5.0	5.6	6.3	7.1	
Nominal heating capacity	kW	2.5	2.8	3.2	3.6	4.0	4.5	5.0	5.6	6.3	7.1	8.0	
Power supply	V/N/Hz	220/1/50											
Nominal input power	W	54	54	54	55	55	55	77	77	77	100	105	
Dimensions (W×D×H)	mm	700×450×200						920×450×200			1140×450×200		
Air flow	m ³ /h	500	500	500	560	560	560	750	750	750	920	1000	
ESP (adjustable)	Pa	10 (30)											
Sound pressure level	dB(A)	33			33			35			36	37	
Weight	kg	17.5	17.5	17.5	17.5	17.5	17.5	21.5	21.5	21.5	28	28	
Connection pipe size	Liquid pipe	mm(in)	φ6.35(1/4")				φ6.35(1/4")					φ9.52(3/8")	
	Gas pipe	mm(in)	φ9.52(3/8")				φ12.70(1/2")					φ15.88(5/8")	
	Condensate drain pipe	mm	DN25										

DC slim duct

Model (TMDN-XX-ACB)		022	025	028	032	036	040	045	050	056	063	071	
Nominal cooling capacity	KW	2.2	2.5	2.8	3.2	3.6	4.0	4.5	5.0	5.6	6.3	7.1	
Nominal heating capacity	KW	2.5	2.8	3.2	3.6	4.0	4.5	5.0	5.6	6.3	7.1	8.0	
Power supply	V/N/Hz	220/1/50											
Nominal input power	W	40	40	40	45	45	50	50	50	50	60	60	
Dimensions (W×D×H)	mm	700×450×200						920×450×200			1140×450×200		
Air flow	m ³ /h	500	500	500	560	560	750	750	750	750	920	1000	
ESP (adjustable)	Pa	10 (30)											
Sound pressure level	dB(A)	33			33			35			36	37	
Weight	kg	17.5	17.5	17.5	17.5	17.5	21.5	21.5	21.5	21.5	28	28	
Connection pipe size	Liquid pipe	mm(in)	φ6.35(1/4")				φ6.35(1/4")					φ9.52(3/8")	
	Gas pipe	mm(in)	φ9.52(3/8")				φ12.70(1/2")					φ15.88(5/8")	
	Condensate drain pipe	mm	DN25										

High static pressure duct

Application scenario: office, etc.

Model

100 112 125 140

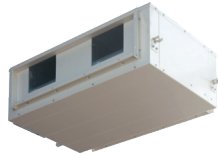

High static pressure enabling far air supply

The external static pressure reaches 200Pa, making it possible to connect long air duct to realize long distance air supply, especially suitable for scenarios needing air supply by long air ducts.

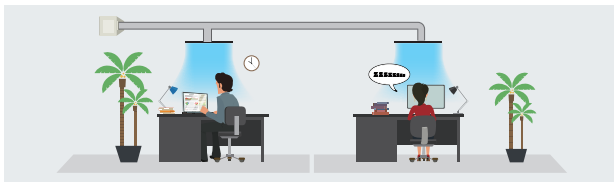

Intake fresh air to improve air quality

Small amount of outdoor fresh air can be introduced through the air duct to ensure the quality of room air.

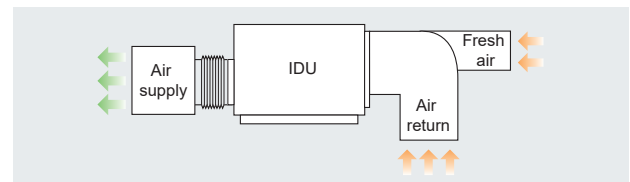

Exclusive filter settings

The antibacterial filtering layer including photocatalyst and activated carbon can effectively remove odors, dust, smoke, and formaldehyde, benzene and other hazardous substances in decorative materials to create a comfort room with fresh air.

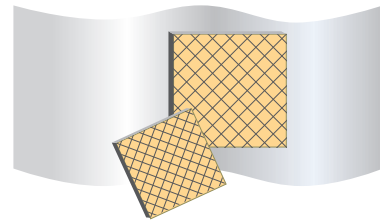

Various air supply modes suitable for different room types

Choosing different air supply modes as per room structure, one IDU of air conditioner can meet the diversified space requirements.

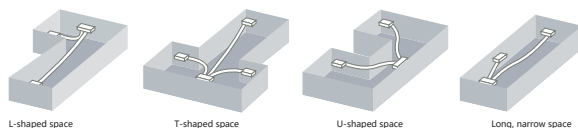

L-shaped space

T-shaped space

U-shaped space

Long, narrow space

Industry-leading with low noise operation

Brand-new noise reduction technology effectively reducing noises of the unit to provide quiet and pleasant environment.

Wired control and wireless control

Both wired controller and micro wireless controller are available.

Hidden installation and elegant appearance

The IDU and duct are in the ceiling and can fit into the interior decoration perfectly.

High static pressure duct

Application scenario: stadium, cinema, and other large-space sites

Model

200	250	335	400	450
500	560	615		

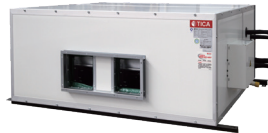

Patented labyrinth box structure with air leakage rate as low as 0.029%

TICA obtained the patent for its first invention - labyrinth structure air handling unit in 1998. Since then, opening up a new chapter for AHU in China. TICA's high-capacity duct type IDU is designed with this patent. The junction part of the unit uses aluminum profile with a concave groove and a convex groove and is secured with bolts and nuts to form a labyrinth sealing structure, achieving the air leakage rate as low as 0.029% - only 1/66 of the air leakage rate allowed in the national standard and realizing lower operating costs.

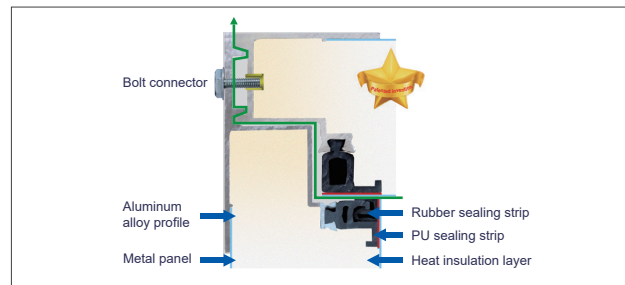

300Pa ultra-high static pressure design, suitable for large spaces with high ceiling

TICA's high-capacity duct IDU has the static pressure up to 300 Pa, making it possible to connect extra-long air duct to realize long distance air supply as high as reaching the suspended space, suitable for high reaching space at individual building below 20,000 square meters and partial high reaching space.

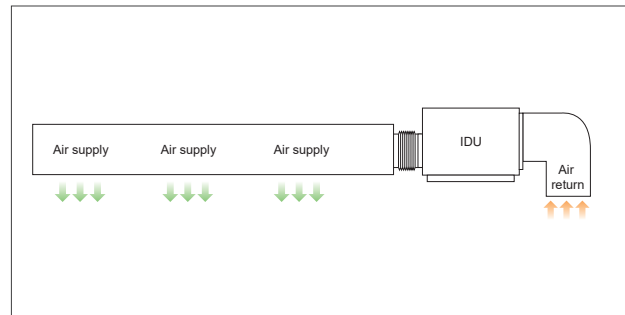

Robust double-wall design eliminating cold bridge condensate

All the metal parts in the cabinet of TICA's high-capacity duct IDU are isolated from outside metal parts using polyurethane foam and specially designed sealing strips, avoiding the thermal insulation strips attached inside the common product to prevent condensation. Cold bridge and dripping are resolved, and the system noise is lower.

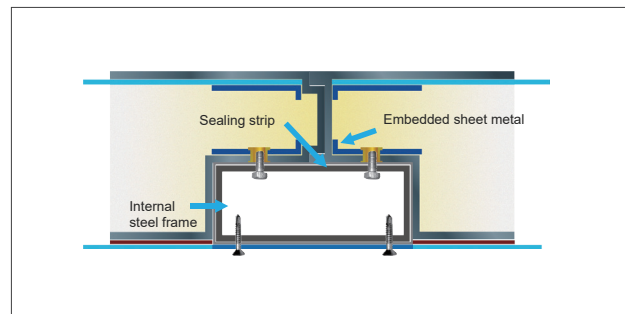

Purification section (optional) for fresh and clean indoor air

TICA has the core competency in the air cleaning industry. TICA AHUs have been the most popular in domestic market for a continuous five years. In sectors such as micro-electronics, surgery operation room equipment and biopharmaceuticals, TICA products also account for over 40% of the total share, making the brand No. 1 in the market. Purification function can also be provided for TICA's high-capacity duct IDU for fresh and clean air in rooms.

Specifications

High static pressure duct

Model		TMDH-XX-AB				TMDH-XX-BI								
		100	112	125	140	200	250	335	400	450	500	560	615	
Nominal cooling capacity	kW	10.0	11.2	12.5	14.0	20	25	33.5	40	45	50	56	61.5	
Nominal heating capacity	kW	11.2	12.5	14.0	16.0	22.4	27	37.5	45	50	56	63	69	
Power supply	V/N/Hz	220/1/50				380/3/50								
Nominal input power	W	400	420	500	550	1100		2200		3000				
Dimensions (W×D×H)	mm	1200×750×390				906×1410×590			1006×1860×800				1006×2360×840	
Air flow	m ³ /h	1800	2000	2250	2700	4000	4000	7000	7000	9000	9000	10000	10000	
ESP	Pa	50 (100/200)				200		250				300		
Sound pressure level	dB(A)	49		51		54		55		57		59		
Weight	kg	62				100	100	200	200	200	200	260	260	
Connection pipe size	Liquid pipe	mm(in)	φ9.52(3/8")			φ12.70(1/2")		φ15.88(5/8")				φ19.05(3/4")		
	Gas pipe	mm(in)	φ15.88(5/8")			φ22.23(7/8")		φ28.58(1 1/8")				φ31.75(1 1/4")		
	Condensate drain pipe	mm	DN25				DN32							

Full-fresh air handling unit

Application scenario: stadium, cinema, and other large-space sites

Model

120 175 210 250 300 400

500 600

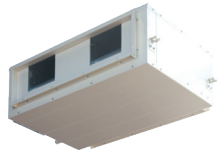

Intake fresh air to improve air quality

TIMS all fresh air handling unit can efficiently and precisely make the outdoor air close to room temperature through the indoor heat exchanger and the powerful heating/cooling capacity, so as to meet various requirements.

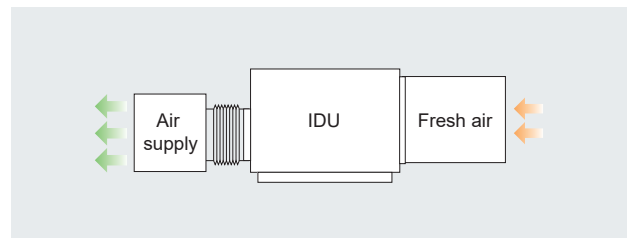

Multi-split unit for multi-point air supply

Air outlets can be flexibly configured to meet the requirements for multi-point air supply.

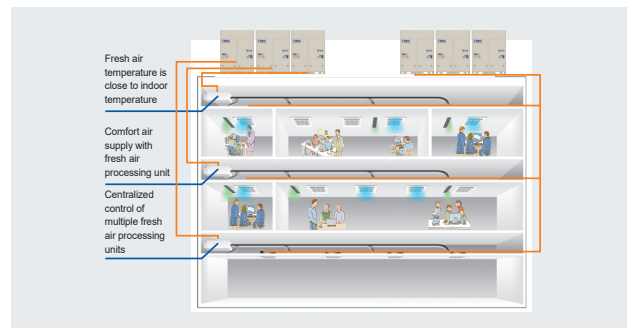

300Pa ultra-high static pressure

All fresh air handling unit has the static pressure up to 300 Pa, making it possible to connect extra-long air duct to realize long distance air supply and bring fresh and clean air to indoor places.

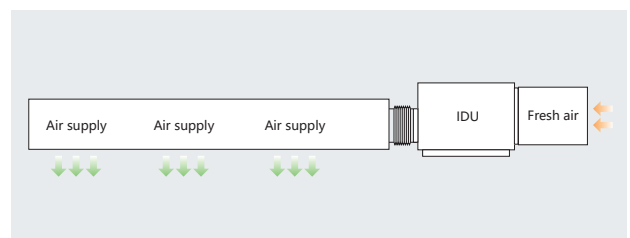

Green and energy saving R410A refrigerant

R410A refrigerant and DC inverter technology have no harm to the ozone layer, featuring energy-saving operation.



Specifications

Full-fresh air handling unit

Model (TMDf-XX)		120A-020	175A-022	210A-020	250A-015	250A-020	250A-030	300A-020	400A-020	400A-030	500A-020	500A-030	600A-020	600A-030	
Nominal cooling capacity	kW	14.0	25.0	28.0	28.0	28.0	28.0	28.0	45.0	45.0	56.0	56.0	56.0	56.0	
Nominal heating capacity	kW	10.0	14.0	17.4	17.4	17.4	17.4	17.4	28.0	28.0	35.0	35.0	35.0	35.0	
Power supply	V/N/Hz	220/50				380/3/50									
Nominal input power	W	330	630	700	480	560	790	750	880	1290	1000	1400	1350	1700	
Dimensions (W×D×H)	mm	1200×750×390	1300×820×500					1650×850×665			2000×850×665				
Air flow	m ³ /h	1200	1750	2100	2500	2500	2500	3000	4000	4000	5000	5000	6000	6000	
ESP	Pa	200	220	200	150	200	300	200	200	300	200	300	200	300	
Sound pressure level	dB(A)	49	49	49	52	55	58	56	59	62	62	65	62	65	
Weight	kg	60	75	75	75	75	75	75	140	140	165	165	165	165	
Connection pipe size	Liquid pipe	mm(in)	φ9.52(3/8")	φ12.70(1/2")					φ12.70(1/2")			φ15.88(5/8")			
	Gas pipe	mm(in)	φ15.88(5/8")	φ22.23(7/8")					φ28.58(1 1/8")			φ28.58(1 1/8")			
	Condensate drain pipe	mm	DN25												

Wall-mounted

Application scenario: bedroom, living room, dormitory, etc.

Model

28 36 40 56



Streamlined design with elegant appearance

The unit has elegant profile and various interiors. The newly designed louver can help with better air-flow diffusion of the conditioner, uniformly distributing air into the whole space in a comfortable way.



Air supply with wide air flow achieving more significant effect

The unique two-layered auto swing providing wider air supply range to optimize air flow compared to conventional units.



Simple and convenient control

The smartly designed wireless controller supports various control functions such as mode setting, fan speed change, and unit on/off for energy efficient operation and enhanced comfort.

Easy maintenance

The removable air return outlet panel facilitates the cleaning of filter and panel.

Ultra-silent operation leading a quiet life

Brand-new highly efficient noise reduction motor built with the latest technology minimizing the noise of IDU; air duct designed with good sound insulation ensuring silent and smooth air supply.



Fast heating providing a warm and comfortable environment

Optimized interior U structure can greatly increase the temperature at air outlet to reach set temperature ASAP and realize fast heating.

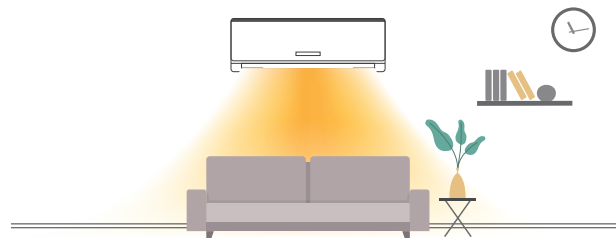

Specifications

Wall-mounted

Model (TMVW-XX-ACB)		028	036	040	056	
Nominal cooling capacity	kW	2.8	3.6	4.0	5.6	
Nominal heating capacity	kW	3.0	4.3	4.5	6	
Power supply	V/N/Hz	220/1/50				
Nominal input power	W	65	65	70	70	
Dimensions (W×D×H)	mm	803×209×287			913×209×287	
Air flow	m ³ /h	600	600	600	750	
Sound pressure level	dB(A)	40			45	
Weight	kg	12	12	12	13	
Connecting pipe Dimensions	Liquid pipe	mm(in)	φ6.35(1/4")			φ9.52(3/8")
	Gas pipe	mm(in)	φ9.52(3/8")			φ15.88(5/8")
	Condensate drain pipe	mm	DN20			

Ceiling & Floor

Application scenario: dining room, study room, dining room, hotel, etc.

Model

28 36 56 71 90 112

125 140



Ceiling and floor types

The innovative design enables both ceiling installation and floor installation. The trendy appearance makes the unit perfectly match your indoor decoration.



Wide-range air supply for even air flow

Auto wide-range air supply guaranteed gentle, natural, and even air flow. Various air supply modes are available. Anti-cold wind design ensures more comfortable air supply in winter.

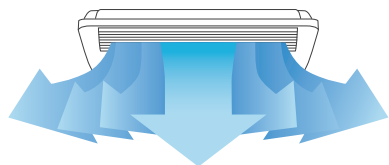

Easy maintenance

The removable air return outlet panel facilitates the cleaning of filter and panel.

Single-side simple and convenient maintenance

All maintenance work and the removal of fan and motor can be implemented through the access hole on the side.

Elegant appearance

The ultra-thin structure makes the unit suitable for various decoration styles.

Special filter settings for improved indoor air quality

An efficient filter device is equipped to completely filter dust, smoke and other small particles in the air, effectively preventing bacteria breeding and thoroughly improving the air quality. For each breathe you take, the air is fresh and natural.

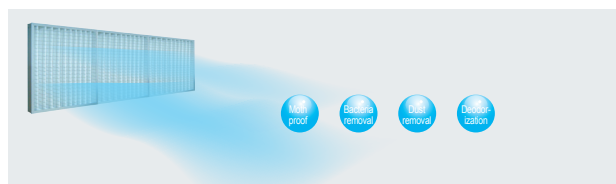

Low noise and low energy consumption

Unequally spaced oblique angle large diameter through-flow fan is used to ensure strong air supply, lower fan speed and lower energy consumption.

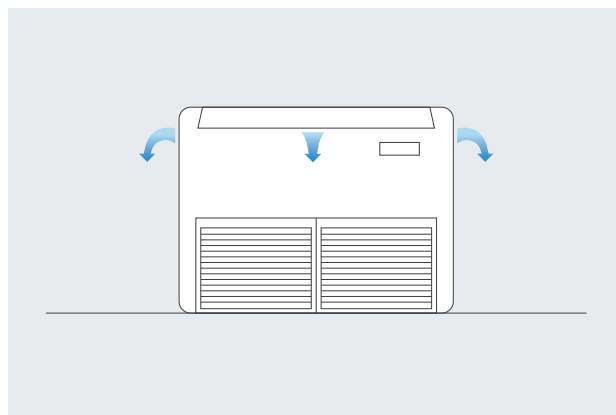

Specifications

Ceiling & Floor

Model (TMVX-XX-A)		028	036	056	071	090	112	125	140
Nominal cooling capacity	kW	2.8	3.6	5.6	7.1	9.0	11.2	12.5	14.0
Nominal heating capacity	kW	3.2	4.0	6.3	8.0	10.0	12.5	14.0	16.0
Power supply	V/N/Hz	220/1/50							
Nominal input power	W	48	62	85	120	156	210	240	240
Dimensions (W×D×H)	mm	905X673X243			1288X673X243		1672X673X243		
Air flow	m ³ /h	450	600	820	1100	1470	1800	2000	2000
Sound pressure level	dB(A)	42	43	45	47	49	50	51	51
Weight	kg	28	28	30	40	40	45	45	45
Connection pipe size	Liquid pipe	mm(in)	φ6.35(1/4")			φ9.52(3/8")			
	Gas pipe	mm(in)	φ12.70(1/2")			φ15.88(5/8")			
	Condensate drain pipe	mm	DN25						



Fresh Air Solutions

Care for every breath

97%

PM2.5 purification efficiency *1

90%

Formaldehyde purification efficiency *2



Fresh air introduction



Efficient PM2.5 filter



Chemical removal of formaldehyde



Sterilization

Indoor air purification unit

► PM2.5 filter layer

Low resistance

Polyethylene + polyene hot melting material can reduce the wind resistance of filters.

High dust holding capacity

The gradually changing density can increase the dust holding capacity, prolong the service life of filter, and reduce the replacement cost.

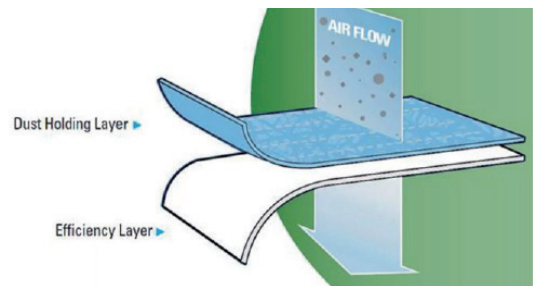

► Formaldehyde filter layer

Conventional method: activated carbon adsorption

At high temperature and when saturated, there is a risk of secondary omission.

TICA solution: chemical removal of formaldehyde

The filter surface is evenly applied with primary amine, which can decompose formaldehyde without the risk of secondary omission.

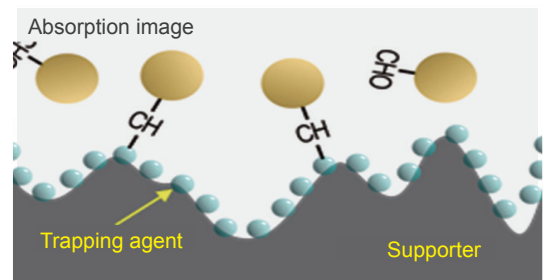

► Disinfection filter

- Metallic ions can interfere with cell wall and cytomembrane synthesis. Then, cells could be killed since the cell wall and cytomembrane lost the completeness.
- Metallic ions can suppress protein synthesis and kill bacteria, so as to effectively prevent microorganism breeding.



► Specifications

Model (TRP-XX-CPF)		070	090	110
Material			Aluminum alloy	
Color			White	
Rated air flow	m³/h	560	750	1000
Air flow range	m³/h	310 - 700	700 - 900	900 - 1100
Windward fan speed range	m/s	0.61 - 0.36	1.02 - 1.31	1.05 - 1.28
Resistance range	Pa	7 - 22.5	14.6 - 20.4	15.3 - 21.1
Outline dimensions (L×W×H)	mm	1006x306x59	1226x306x59	1446x306x59
Area of windward side (L×W)	mm	672x214	892x214	1112x214
Area of installation (L×W)	mm	980x270	1200x270	1420x270
PM2.5 cycle	2h	≥97%	≥97%	≥97%
Formaldehyde cycle	1h	≥90%	≥90%	≥90%
Weight	kg	3.1	3.7	4.4

HRV

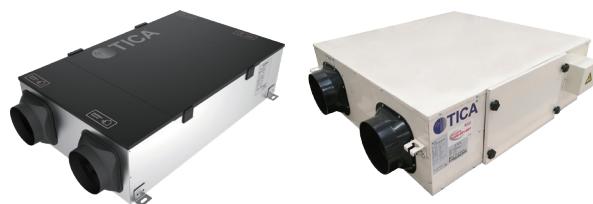

► Multiple haze removal

Must-have for haze removal

- Filtering offers layers of protection.
- The maximum PM2.5 removal rate is 95%.

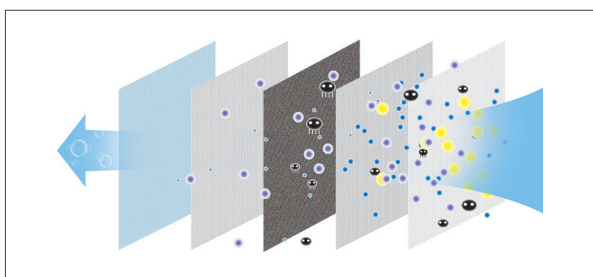

► Omni-directional air replacement

Fresh air enjoyed without opening the window

The unit is ceiling-mounted in places not that noise-sentimental. With all air ports put indoors, it can ensure that air is supplied and discharged evenly and smoothly.

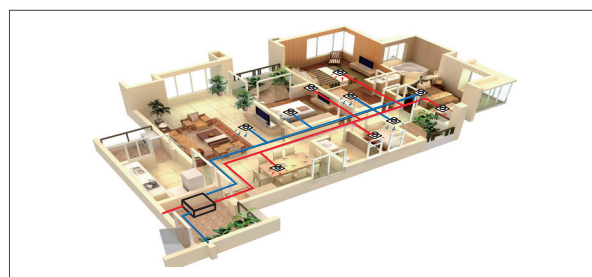

► Highly efficient energy recovery

Efficient heat exchange core

- The heat recovery core is formed by cross-laminating and rotating the single-sided corrugated, parallel paper sheets by 90°, with two mutually vertical and non-interfering channels. The fresh air and return air are able to exchange heat and humidity without being mixed when passing the two channels.
- With the latest technology of Japan, the parallel paper is even and tight, and boasts a heat recovery rate of 80%.

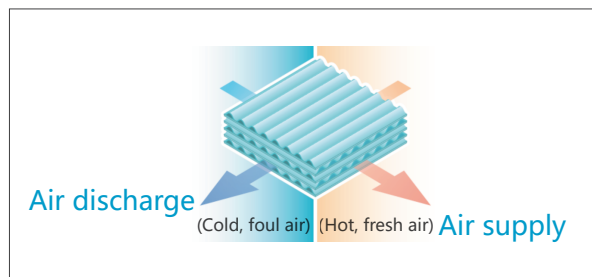

► Specifications

Model (TRV-XX)		015	025	035	050
Power supply	V/N/Hz	220/1/5			
Power Input	W	105	135	276	365/380
Current	A	0.5	0.6	1.25	1.7/1.76
Air flow rate	m ³ /h	150	250	350	500
Purification efficiency	%	95	95	95	95
ESP	Pa	80	80	80	50/100
Heat exchange efficiency (heating/cooling)	%	85/67	82/63	80/62	73/61
Enthalpy exchange efficiency (heating/cooling)	%	75/55	72/52	68/51	64/50
Sound pressure level	dB(A)	32	34	39	43
Net Weight	kg	24	24	27	53

Standard series fresh air ventilators

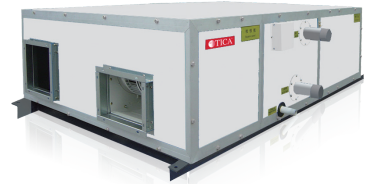

► Patent structure and low air leakage rate

The junction part of the unit uses aluminum profile with a concave groove and a convex groove and is secured with bolts and nuts to form a patented labyrinth sealing structure, achieving the air leakage rate as low as 0.029% - only 1/66 of the air leakage rate allowed in the national standard and realizing lower operating costs.

► High efficiency and energy saving

The full core heat exchanger achieves high heat exchange efficiency, temperature efficiency as high as 70% and enthalpy efficiency as high as 60%.

► Elimination of cold bridge and rust

All the metal parts in the cabinet of TICA's high-capacity duct IDU are isolated from outside metal parts using polyurethane foam and specially designed sealing strips, avoiding the thermal insulation strips attached inside the common product to prevent condensation. Cold bridge and dripping are resolved, and the system noise is lower.

► Safe and reliable

The direct driven fan does not require maintenance. Only the filter needs to be cleaned regularly.

► Specification

Model (TFD-XX)			010FC	015FC	020FC	025FC	030FC	040FC	050FH	060FH	080FH	105FH
Air flow		m ³ /h	1000	1500	2000	2500	3000	4000	5000	6000	8000	10500
ESP	Air supply	Pa	90	110	120	110	100	110	100	100	110	100
	Air discharge	Pa	90	110	120	110	100	110	100	100	110	100
Cooling	Temperature recovery efficiency	%	61	59	61	58	59	57	57	59	57	57
	Enthalpy recovery rate	%	52	51	53	50	51	50	50	51	50	50
Heating	Temperature recovery efficiency	%	72	71	73	70	71	69	69	71	69	69
	Enthalpy recovery rate	%	60	59	61	58	59	58	58	59	58	58
Motor power	Air supply	kW	0.2	0.3	0.45	0.55	0.55	1	1.5	0.55X2	1.00X2	1.50X2
	Air discharge	kW	0.2	0.3	0.45	0.55	0.55	1	1.5	0.55X2	1.00X2	1.50X2
Sound pressure level		dB(A)	53	53	55	56	58	59	62	62	63	66
Power supply		V/N/Hz	220/1/50				380/3/50					

High-end series fresh air ventilators

► Features

Wide air flow rang of 1000m³/h~6000m³/h; applies to occasions such as residences, meeting rooms, labs, offices, equipment rooms, restaurants, and gyms.

Convenient installation: The machine is positioned in the ceiling and does not occupy the indoor effective space.

More features: Two-way ventilation, and energy recovery.

Structural design: The product is designed with a sheet metal structure, with insulation cotton attached inside.

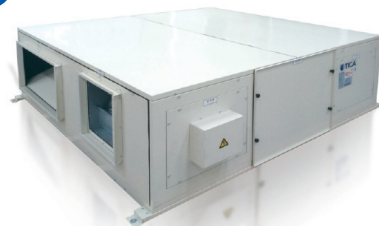

Model (TRD-XX)			100	150	200	250	300	400	500	600
Fresh air flow		m ³ /h	1000	1500	2000	2500	3000	4000	5000	6000
ESP		Pa	120	160	105	100	150	125	95	120
Enthalpy recovery rate	Cooling	%	51	51	51	51	58	51	57	58
	Heating	%	67	62	61	62	71	65	71	70
Temperature recovery efficiency	Cooling	%	67	61	61	64	64	67	67	67
	Heating	%	82	77	75	80	82	78	82	84
Sound pressure level		dB(A)	45	51	52	53	52	58	59	60
Input power of the entire unit		W	550	920	1310	1630	1900	1940	2790	3280
Current of the entire unit		A	2.7	4.2	6.3	7.6	8.7	5.3	7.3	7.8
Power supply		V/N/Hz	220/1/50				380/3/50			
Net Weight		Kg	100	143	175	185	198	290	360	390

Electronic fresh air smog removal sterilizer

PM2.5 filtration efficiency
91%

Sterilization efficiency
99%

Formaldehyde purification efficiency
90%

Efficient haze removal with no consumables required

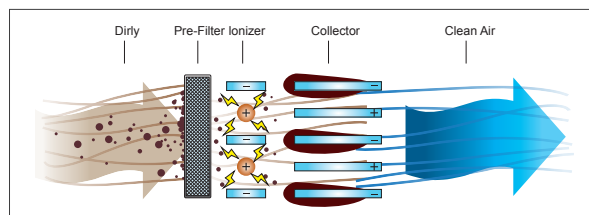

► High purification efficiency

The unit adopts the ESD action to catch dust and pollutant floating in the air when the air flow is passing through a high-voltage field. Air surrounding the negatively charged discharge electrode forms an ionization area, and positively charged ions will move towards the negative plate under the electric field force. Then, particles will be captured by the energy instantaneously released by high voltage electricity and absorbed on the collector.

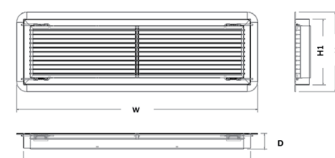

Model (TEFP-XX-APE)		002	004	006	008	010	020	030	040	050	080	100
W	mm	438	438	490	540	640	640	895	895	1111	1564	1760
H	mm	330	360	400	400	400	513	578	678	754	754	754
D	mm	300										
W1	mm	250	250	320	400	500	500	800	800	1400	1400	1600
H1	mm	130	160	200	200	200	320	400	500	630	630	630
Max. air flow processed	m ³ /h	200	400	600	800	1000	2000	3000	4000	8000	8000	10000
Max. power	W	30	30	30	30	30	30	30	60	120	120	120
Max. resistance	Pa	25										
Filtration efficiency (PM2.5)	%	91	91	91	91	85	85	86	85	86	86	85
Power supply	V/N/Hz	220/1/50										

Electronic return air purifier



► Low resistance, energy efficiency

- Resistance as low as 25Pa.
- Power lower than other commercial air purifiers.

► No consumables, low cost

- Filter is durable, easy to clean.
- All-metal body has a more than 20 years life-span.
- Material can be recycled for energy-saving and environment protection.

► Concealed installation and easy maintenance

- Unit concealed in the air conditioning and ventilation system of commercial buildings; no need to change the existing decoration; fresh air supply all the time.
- Air flow up to 15000m³/h and higher purification efficiency.
- Preserved maintenance board to facilitate clean and maintenance.

Model (TRP-XX-AEF)		045	080	120	180	240
W	mm	450	650	1100	1300	1533
H	mm	293	293	293	293	300
D	mm	205				386
W1	mm	300	500	850	1226	1462
H1	mm	226	226	226	226	226
Max. air flow processed	m ³ /h	450	800	1200	1800	2400
Max. power	W	18	18	30	30	30
Max. resistance	Pa	10				
Filtration efficiency (PM2.5)	%	91				
Formaldehyde purification efficiency	%	90				
Power supply	V/N/Hz	220/1/50				



Intelligent Control

Provide you with convenient services

APP

Intelligent control

2048

IDUs centralized control



Individual controller



Centralized controller



Building Management System (BMS)



Software

Various controllers

Remote controller and wired controller

▶ Remote controller

- Mode Setting: Cool/Heat/Dry/Fan/Auto
- Scheduled power-on/off
- Temperature setting
- Fan speed setting: High/Medium/Low/Auto
- Eco/Quiet/Sleep functions
- Vertical swing/Horizontal swing



▶ Standard wired controller



- 86×86mm panel, LED
- Error reporting
- ON/OFF, swing, memory function, etc.
- Cool/Heat/Auto/Fan/Dry modes
- Temperature setting, timer power-on/-off
- Touch keys
- Filter cleaning reminder
- Background light
- Wi-Fi control

▶ Enhanced wired controller



- 86×86mm panel, large LED
- TFT touchscreen
- ON/OFF, one-key humidification, swing, sleep, memory function, etc.
- Cool/Heat/Auto/Fan/Dry modes
- Temperature setting, timer power-on/-off
- Air quality display, power consumption estimation curve
- Filter cleaning reminder
- Background light
- Wi-Fi control

Centralized controller

► Standard centralized controller

- Centralized or separate control of up to 64 IDUs in 8 systems
- Mode locking, single set query/all control functions
- Timer power-on/off
- Fault indication, unified control interface, and user-friendly operation interface
- Mode switching
- Control signal wire can be up to 1000 m long.
- Operating status monitoring
- Error reporting



► Partition controller

- Inter-system control of up to 16 IDUs
- Timer power-on/off
- Fault indication, unified control interface, and user-friendly operation interface

- Mode switching
- Operating status monitoring
- Error reporting

► High-end touchscreen centralized controller

- 8-inch colored touchscreen
- Centralized or separate control of up to 64 IDUs in 8 systems
- Setting, management and monitoring (set temperature, air flow) of IDU
- Accessible to IDU/ODU network
- Support of remote control via APP
- Schedul control by week/month/year
- Unified management of IDU groups
- Statistics of changes in running statuses of all devices in a certain time period, including fault display, parameter status query, device query, and permission management
- Display of indoor PM2.5 and formaldehyde content



*Sensor node is required for IDUs

Building Management System (BMS)

- TIMS adopts multiple BMSs to access to the BAS for comprehensively auto control.
- TICA BMS supports access via BACnet, LonWorks, or ModBus. Up to 1024 IDUs and 16 ODUs can be connected.



Basic control functions

- 1 AC on/off, operation, and monitoring the operation status
- 2 Monitoring the IDU error code
- 3 Monitoring and setting the IDU temperature
- 4 Monitoring and switching the operating mode
- 5 Remote controller lock function
- 6 Service monitoring
- 7 Auto running
- 8 Mode lock function, user can lock the running mode of indoor unit
- 9 Free management by group
- 10 Complete schedule management
- 11 Historical data records
- 12 Schedule control by week/month/year
- 13 Centralized control function
- 14 Interlock control (fire alarm, door lock, fault, etc.)

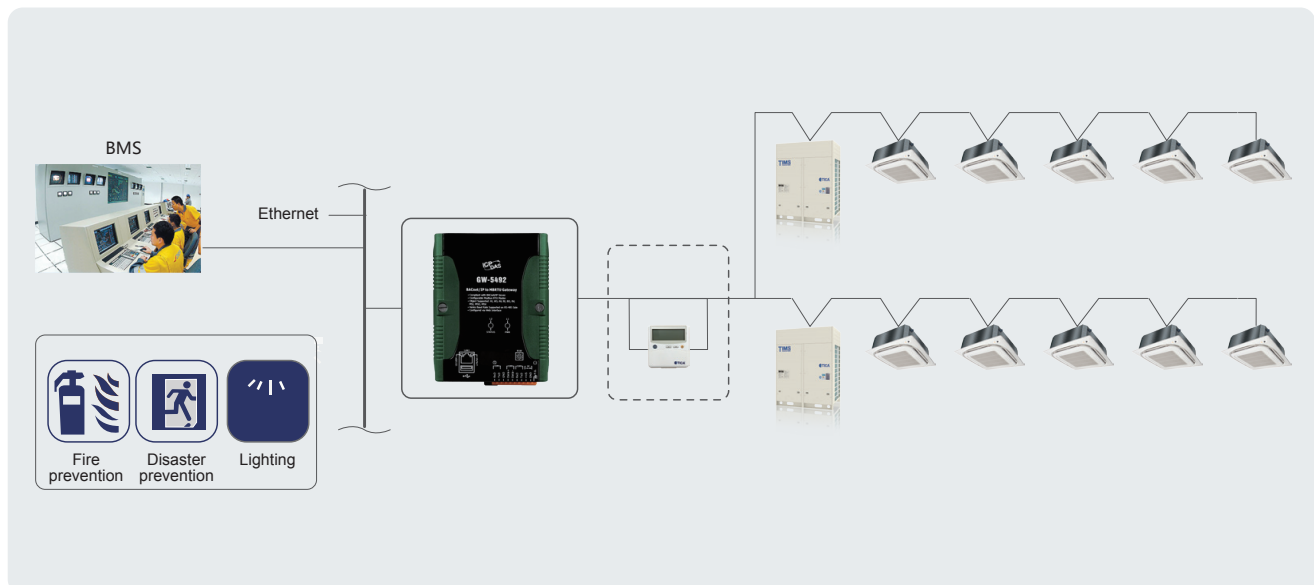

Remote control system

TICA TIMS VRF can be connected to an external smart gateway for data uploading to a cloud server. In this way, remote control can be implemented anytime and anywhere. Users can check the air conditioner status, start/stop the unit, and adjust the temperature remotely.

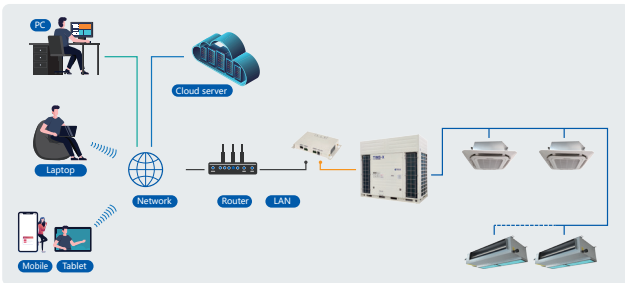

► Real-time monitoring of indoor air quality

Temperature & humidity and PM2.5 sensor, Monitors indoor air quality in real time.



► Smart APP control

Follow TICA's WeChat official account or download the mobile App of TICA intelligent air quality to intelligently manage every of your air conditioners.

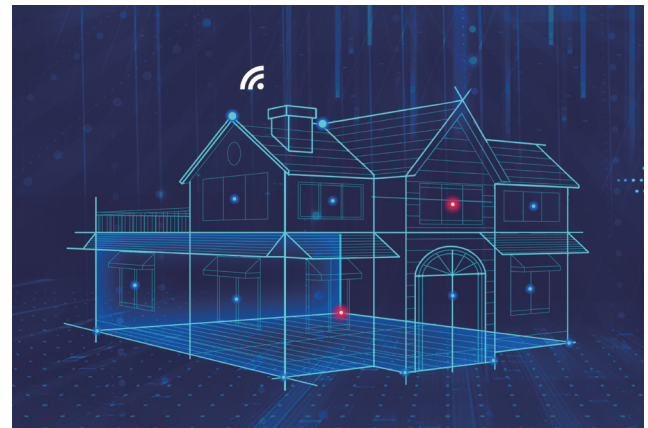
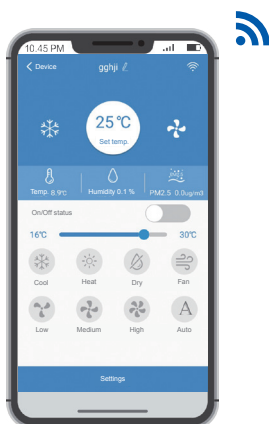

Intelligent software

The IDUs are connected to a computer by the data acquisition module, so that full centralized control can be implemented on this management software. The control function is very powerful, and operations are simple and clear. One set of software supports up to 32 systems and 2048 IDUs for large-scale centralized control. The control signal of data acquisition module can reach up to 1200 m.

- Free management by group
- Complete schedule management
- Historical data records
- Schedule control by week/month/year
- Centralized control function
- Centralized control over air conditioning systems in multiple buildings at the same place
- Permission setting
- Temperature setting, timer power-on/-off
- Error reporting
- Interlocking control
- Remote management



Account

Password

Remember password

OK Cancel

- The household-based charging software has the complete functions of unit monitoring and control, and can implement omni-directional and dynamic monitoring on the ODU operating status.
- Network control is realized for a maximum of 2048 IDUs, and the control signal of data acquisition module can reach up to 1200 m.
- The topology diagram of refrigeration system can be set and displayed visually.
- Proven electricity fee allocation algorithm and convenient fee allocation management, generation of detailed historical data tables.
- User accounts, electricity prices and groups can be set so as to facilitate flexible management on VRF unit household-based charging.



► System energy-saving settings

1

Temperature management – intelligent temperature management of cooling and heating operations

2

Operation time management of air conditioning

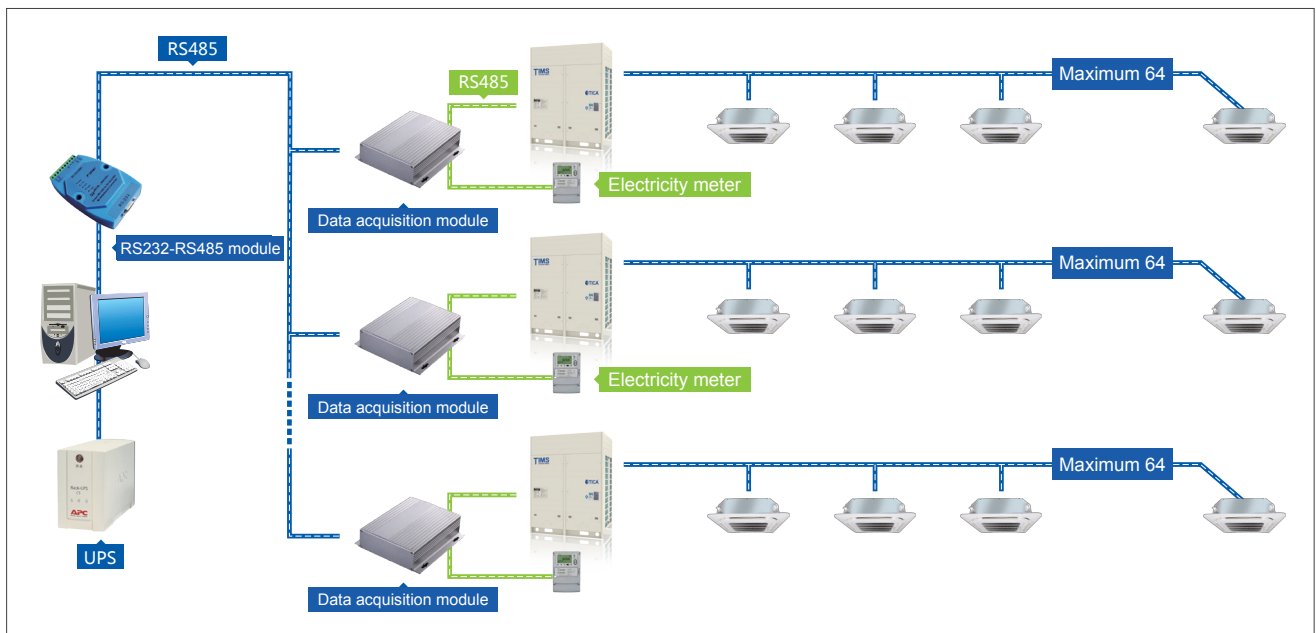

Branch Pipe

Model	Appearance	Dimension	
		Gas side joints	Liquid side joints
TBP4022TA			
TBP4033TA			
TBP4072TA			
TBP4073TA			
TBP4090TA			
TBP4135TA			

Branch Pipe

Project Reference



Indonesia Gotong Royong Hospital



Ukraine Citi Dotor



Uzbekistan AKFA Medline Clinic



Russia BIOCAD Biopharmaceutical Company



Indonesia Sinar Meadow factory



Vietnam Bitland factory



Indonesia The Park Semarang mall

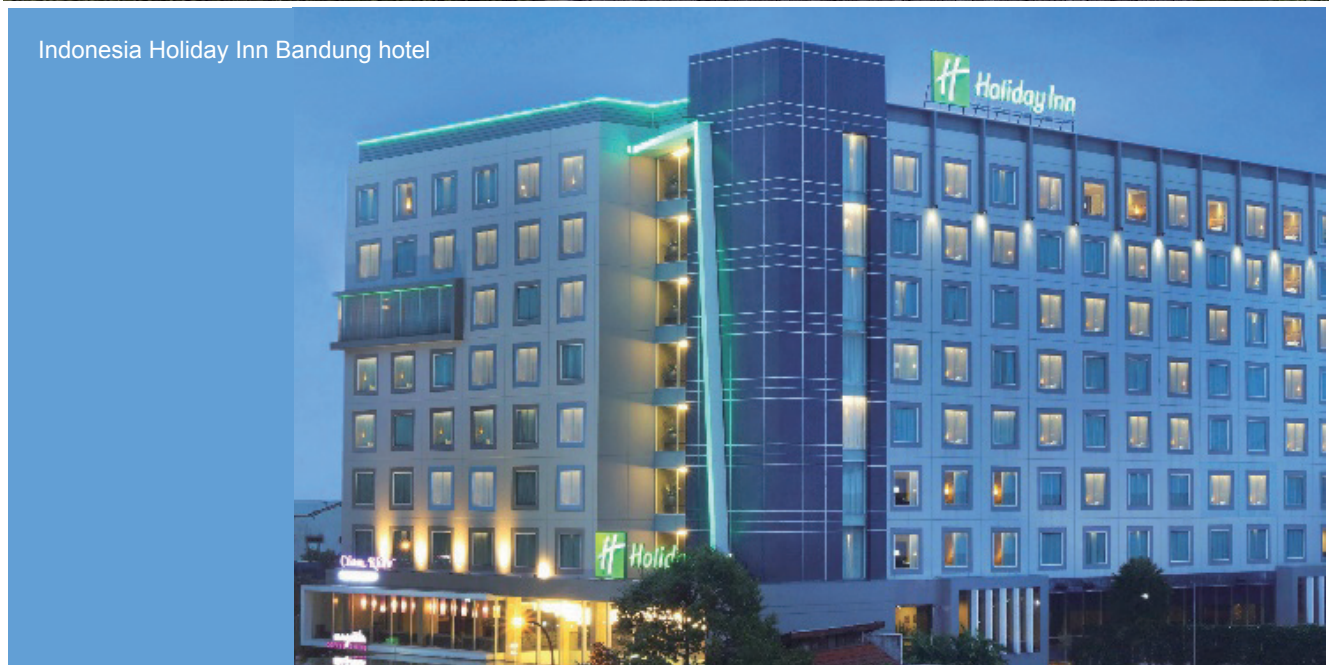

Indonesia Holiday Inn Bandung hotel

Beijing Xiaotangshan Hospital



The Sixth People's Hospital of Chengdu



Longling Nursing Center for Elders



Jiangbei International Branch of Drum Tower Hospital



New Nanyuan Airport



Chengdu-Guiyang High-speed Railway



Guangzhou Metro Line 14



Hangzhou Xiaoshan International Airport



Dongguan World Trade Center



Nanjing Weijing International Hotel

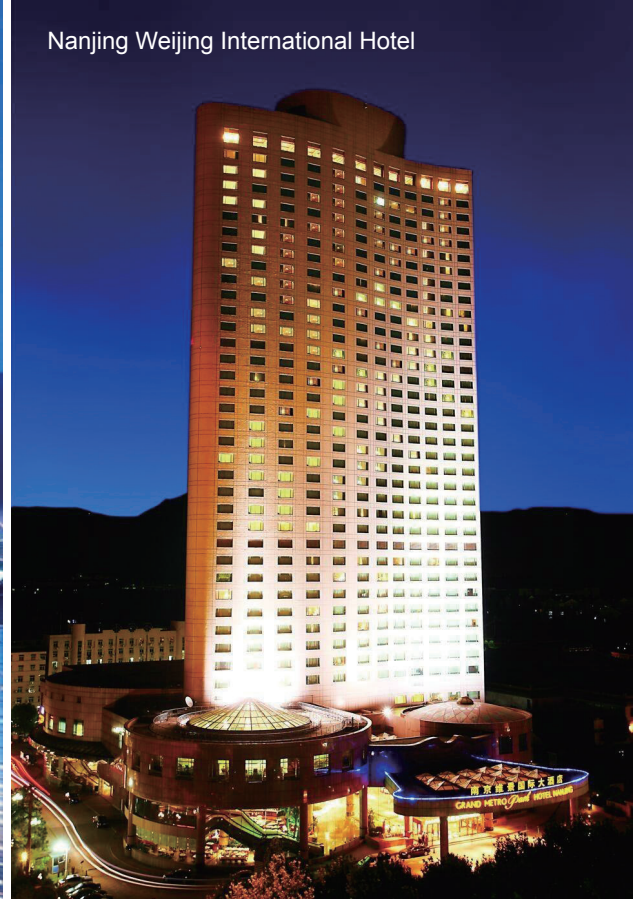

Shanghai Guanfu Baoku Art Center



UB Freight office building



New campus of Beihai Party School



Beijing Normal University

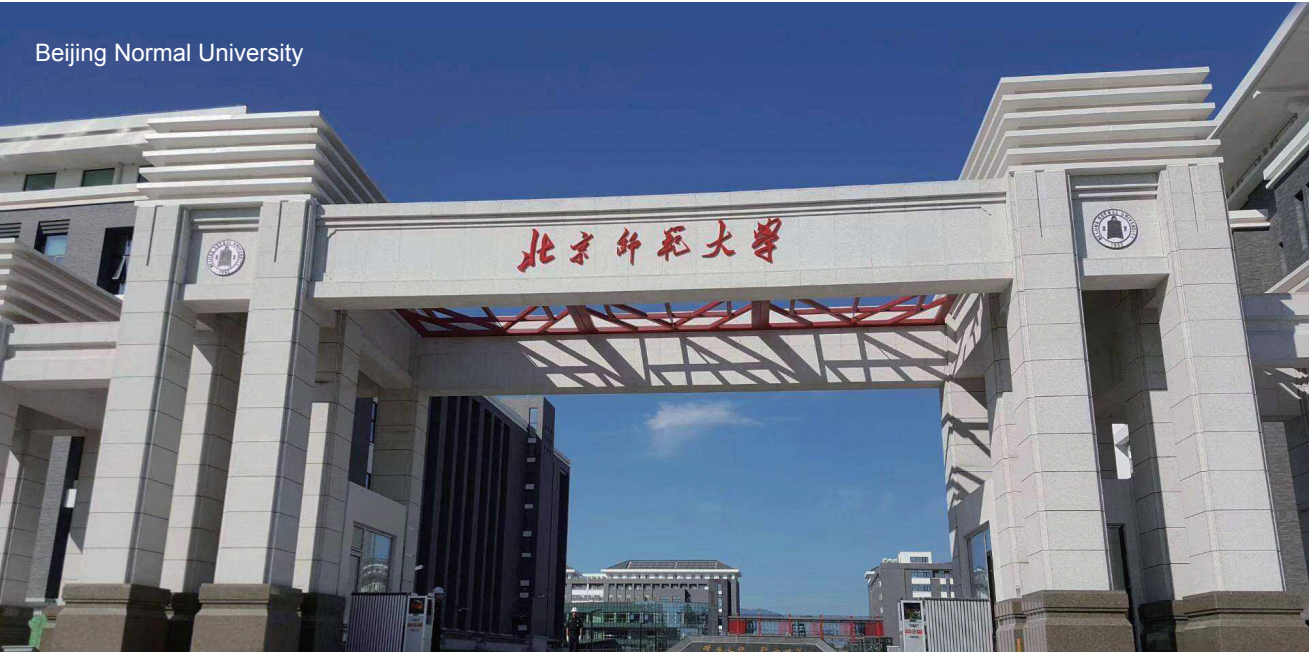

Cambodia integrating hotel



Sun Yat-Sen University





Belarus Capital Palace



UB Freight office building





Follow the Account of TICA to see more solutions

Nanjing TICA Climate Solutions Co., Ltd.
Address: No.6, Hengye Road, Nanjing Economic and Technological
Development Zone, China Postal code: 210046
Tel: 86-25-85326977
E-mail: global@ticachina.com
Website: www.global.tica.com

Note: Due to constant improvement and innovation of TICA's products, the product models, specifications and parameters contained in this document are subject to change without prior notice.